



Serial No. N7524

NAFO SCR Doc. 24/019

**SCIENTIFIC COUNCIL MEETING – JUNE 2024**

Biomass and Abundance of Demersal Fish Stocks off West and East Greenland estimated from the Greenland Institute of Natural resources (GINR) Shrimp and Fish Survey (SFW), 1990-2020, and 2022-2023.

By

Rasmus Nygaard and Adriana Nogueira  
Greenland Institute of Natural Resources, Box 570, 3900 Nuuk, Greenland

**Abstract**

Since 1988, the Greenland Institute of Natural Resources has annually conducted a bottom trawl survey off West Greenland (NAFO SA1). The survey was initially designed with the focus to evaluate the biomass and abundance of the Northern shrimp (*Pandalus borealis*). Fish have systematically been recorded since 1992. In 2008, the survey was expanded to include the East Greenland shelf area using the same gear and depth range. From 1991 to 2017, the survey was conducted with the research vessel Pâmiut. Chartered commercial vessels of similar size have been used from 1988-1990, 2018 (Sjudarberg) and 2019-2020 (Helga Maria). No survey was conducted in 2021. From 2022, the annual trawl survey was conducted with a new research vessel R/V Tarajoq. An examination of gear parameters found that the effects of these vessel changes had a minimal effect on trawl performance (Nogueira and Treble 2020, Nogueira et al., 2023).

The gear was changed prior to the 2005 survey from a shrimp trawl with steel bobbins (Skjervoy) to a slightly larger shrimp trawl with rock-hoppers (Cosmos trawl). All the standard gear from the research vessel Pâmiut (such as cosmos trawl, doors, all equipment such as bridles, Marport sensors on doors, headlines, etc..) were used on the chartered commercial vessels, and in the new research vessels in attempt to make the survey identical as possible. No survey was conducted in East Greenland years 2018-2022.

This paper contains biomass and abundance indices, length distributions and maps of survey densities for Greenland halibut (*Reinhardtius hippoglossoides*), Atlantic cod (*Gadus morhua*), redfish (*Sebastes norvegicus* and *Sebastes Mentella*), Atlantic wolffish (*Anarhichas lupus*), Spotted wolffish (*Anarhichas minor*), American plaice (*Hippoglossoides platessoides*) and Thorny skate (*Amblyraja radiata*).



## Materials and Methods

### *Survey design, stratification and area coverage*

In West Greenland, the trawl survey initially covered the traditional offshore shrimp area, between 60° - 72° north and was restricted to depths from 150-600m. In 1991 the survey was expanded to include the Disko Bay and in 1992, south Greenland was included in the survey. Since then, the survey has covered continental shelf from Cape Farewell in the south to latitude 72°30'N including the Disko Bay in NAFO subarea 1 and in some years including the part where the shelf bulges into the Canadian EEZ, a small area in the eastern part of NAFO Div. 0A. The area is delimited by a line 3 nm off the base line and the 600 m depth curve. Areas shallower than 150 m was initially sporadically covered, but from 2004 two extra depth zones have been formally included (50-100m, and 100-150m).

The survey area is divided into primary and secondary strata. The survey primary strata correspond to geographical areas identified on the basis of logbook information on the distribution of the shrimp fishery (Carlsson *et al.* 2000). The primary strata are further subdivided into secondary (depth) strata at 150–200 m, 200–300 m, 300–400 m, and 400–600 m. When the survey was initiated, bathymetric information in Disko Bay, as well as offshore north of 69°30'N, did not support this depth stratification, and these regions were therefore originally subdivided into geographical substrata not based on depth. Depth data logged by the survey and other investigations eventually allowed these waters to be stratified on depth and a new geographical stratification with depth sub-strata was introduced in 2004 (Wieland and Kannevorff, 2004). At the same time, the geographical strata in the Canadian zone, formerly two, were merged into one.

From 1988 through 1999, trawl stations were allocated to strata in proportion to stratum area, but since 2000 more stations have been allocated to strata where shrimp biomass variances have been high in previous years in order to improve the precision of the overall biomass estimate (Kingsley *et al.*, 1999). An exponential smoothing of previous years' stratum variances was applied in the allocation procedure, giving higher influence to the more recent years. Past variance data for Atlantic cod and Greenland halibut is also made available to the allocation procedure, which is now set to minimize a weighted combination of the expected survey precision for the three species.

The station layout is based on a division of the survey area into elements about 2 nautical miles square. Since 1999 survey stations have been positioned using 'buffered random' sampling, in which stations are placed randomly with the constraint that a minimum distance between them, which depends on station density within the stratum, must be observed (Kingsley *et al.*, 2004).

From 1988 through 1998, survey designs were independent from year to year, stations being placed anew in the strata. Since 1999 about 50% of the stations included in the preceding year's design have been repeated as fixed stations in the following year, the others being placed, as before, using the buffered sampling rules. Catches are correlated from year to year by position, and fixing stations improves the ability of the survey to indicate year-to-year changes in stock size by inducing serial correlation in survey error (Kingsley, 2001a).

In East Greenland, the survey is carried out with the same gear and survey protocols as used in West Greenland since 2005. Stratification is based on the "Q-areas" used for the East Greenland survey for Greenland halibut. The areas are further depth stratified into 0-200 m, 200-400m and 400-600 m zones. In East Greenland, bottom conditions severely restrict the areas that can be trawled and in some strata, stations are randomly selected from historical known trawl-able sites. For more information on the results from the survey in East Greenland see ICES NWWG reports.

### *Survey period and daily sampling period*

The trawl survey has been carried out every year between mid-June and the end of August to minimize the effect of seasonal cycles in the biology of the species. Trawling on the main shrimp depths is carried out between 0800 and 2000 UTC to avoid the effects of the daily vertical migration of the Northern shrimp. Shallower stations (0-150m) are occasionally taken outside this timeframe.

### *Tow duration and speed*

From 1988 to 1997 all tows in the shrimp survey lasted 60 min. However, shorter tows give just as accurate results (Carlsson *et al.*, 2000; Kingsley, 2001b; Kingsley *et al.*, 2002; Wieland and Storr-Paulsen, 2006; Ziemer and Siegstad, 2009) and since 2005 the survey has been operated with 15-minute tows alone. Towing speed has been about 2-2.5 knots throughout the years.

### *Survey vessels*

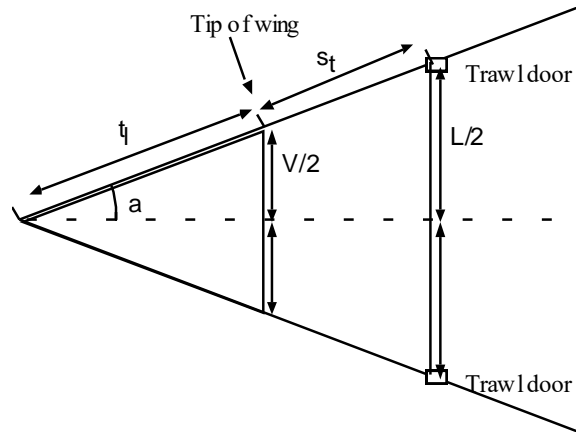
The survey has been conducted with the 722 GRT stern trawler M/Tr 'Pâmiut' from 1991 to 2017, similar vessels were used in 1988-1990. However, in the beginning of 2018 it was decided that the old research vessel Paamiut had to be scrapped owing to increasing expenses to maintenance and the construction of a new research vessel was initiated. From 2018-2020, the survey was conducted with chartered commercial fishing vessels (C/V Sjurdarberg in 2018 and C/V Helga Maria in 2019 and 2020). From 2022 the survey has been conducted with a new research vessels RV Tarajoq. Both chartered vessels and the new research vessels using the Pâmiut fishing gear (Doors, gear trawl and sensors). Examinations of gear parameters found that the effects of these vessel changes had a minimal effect on trawl performance (Nogueira and Treble 2020 and Nogueira *et al.*, 2023). Fishing practice and handling of catch were exactly as used on the research ship Paamiut (Burmeister and Rigét, 2019).

### *The Survey Gear and trawl*

The survey initially used a Skjervoy 3000/20 trawl with steel bobbin gear and double bag. In 2005, the skjervoy trawl was replaced by a Cosmos trawl (Wieland and Bergström, 2005). Until 2003, *Greenland Perfect* trawl doors were used (9.25 m<sup>2</sup>, 2.4 tons), but they were replaced in 2004 by Injector International trawl doors (7.5 m<sup>2</sup>, 2.8 tons) to facilitate the trawl change in 2005. Calibration experiments were conducted in the main shrimp areas in 2004 and 2005 and a formal analysis of conversion factors were established for shrimp (Rosing and Wieland, 2005). Preliminary conversion factors for a few commercial fish species were derived as described by Rosing and Wieland (2005) and are given in table 3. However, the calibration factors were never finally evaluated and in some cases (particularly cod) the calibration factors relied on few data. Without calibration the two separate time series seems well connected for most species indicating that the trawl experiments overestimate the difference between the gears.

### *Swept area calculation*

Nominal swept area for each tow was calculated as the straight-line distance between its GPS start and end positions multiplied by the wingspread. The distance between the trawl doors is recorded 3 or 5 times during each tow; provided it was recorded at least 3 times, wingspread for a tow was calculated from the mean door spread and the geometry of the trawl. For both trawls the wingspread (i.e. the width of the swept area)  $V$  has been calculated as follows. The trawl and the trawl plus bridles are assumed to form two similar triangles, bridles and wings making a straight line:



and the lengths of the bridles ( $s$ ) and the trawl wings ( $t$ ) are known. The wingspread  $V$  is then calculated as:

$$V = (t_i * L) / (t_i + s_t)$$

where  $L$  is the distance between the doors (doorspread).

The length of the *Skjervøy* trawl was 67.15 m and the length of the *Cosmos* trawl is 71.8 m with RV Paamiut and is 71 m with the new vessel R/V Tarajoq, both measures excluding the cod-ends. Since 2004 the bridle length, i.e. the total length of lines, chains and shackles between the trawl doors and the tip of the trawl wing, has been 54 m for either trawl; other bridle lengths were used in earlier years. In the case of the *Skjervøy* trawl, 0.7 m has been added to the calculated wingspread because the *Skjervøy* trawl is a three-winged trawl and the lower wings (directly attached to the ground-rope) were estimated to spread 0.35 meters wider than the middle wings on each side in tank experiments at the Danish Institute for Fisheries Technology and Aquaculture (Per Kannevorff, pers. com.).

### Biomass estimation

Each haul's catch is divided by its estimated swept area calculated from wingspread and track length to estimate a biomass density. Unweighted mean stratum densities were multiplied by the stratum area to calculate stratum biomass, and a corresponding error variance for the stratum biomass estimate was also calculated for strata with two or more accepted hauls. For strata with only one accepted haul, an average error of variance for all strata was assigned. If strata have no stations in a given year, the neighbouring strata with stations in that year is geographically enhanced to include of the non-visited strata. This way the total area surveyed is maintained (since 2005).

## Results

The stratification is based on designated 'Shrimp strata' that is divided into depth zones of: 151-200, 201-300, 301-400 and 401-600 m, as based on depth contour lines (figure. 1). The depth zones 0-100 m and 100-150m are delimited by the NAFO Subdivision boundaries. The strata and their sizes are provided in table 1. The number of valid hauls by year and strata are listed in table 2.

### *Greenland halibut (Reinhardtius hippoglossoides).*

Greenland halibut is widely distributed along NAFO 1A-F, but highest concentrations are found in the important nursery areas on the shelf in division 1A, 1B-north and Disko Bay (table 4 and 5). Highest biomass concentrations are found on the slopes and in the Disko bay. The abundance indices is highly influenced by year to year variability in the number of one- and two-year old recruits, which by number typically constitute 80-90% of the total survey abundance. The biomass and abundance indices increased gradually until the gear change in 2005. Since 2005, the general trend in the abundance indices has been slowly decreasing, with the exception of record high numbers of one-year old recruits observed in 2011, 2013 and 2017. The 2018 and

2019 abundance indices are among the lower observed in the most recent decade, and from 2020 indices show an increasing trend (Figure 2). In West Greenland clear modes can be found in the length distribution at 12-15 and 19-23 cm every year corresponding to ages 1 and 2 (figure 13). In 2023, age 2 biomass is highest than age 1 for the first time in the whole time-series. The biomass index is not influenced by year to year variation in the numbers of one and two year old recruits. The biomass indices increased gradually through the 1990's and until the last year with the old Skjaervoy trawl in 2004. From 2005 to 2014 the biomass index decreased. The decrease mainly occurred in the northern part of division 1B and inside the Disko Bay. After 2014 then the biomass has been gradually increasing.

#### *Greenland halibut recruitment.*

A recruitment index was estimated for the entire survey area. By means of the Petersen-method ages 1, 2 and 3+ were separated in the survey catches. To allow comparison of abundance throughout the time series, data from 1988 to 2004 were converted by a conversion factor to adjust the old Skjervoy to the new Cosmos trawl catches. For Greenland halibut the calibration was length dependent (Table 3).

The number of one-year-old fish in the total survey area including Disko Bay (NAFO Divisions 1A-F) increased gradually from 1996 to a peak in 2003 (470 millions indiv.)(Fig. 9). Since then, the abundance decreased until 2014, with the exception of two exceptionally recruitment events of more than 1000 millions of indiv. in 2011 and 2013. The recruitment has been dropping from 2017 (449 millions indiv.) to 2019 (101 millions indiv.)(lowest value of the time series). In 2020, recruitment increased (291 millions indiv.) reaching almost 2016 values. We observe a slight decrease from 2020. In 2022, the recruitment was estimated at 156 millions indiv. Almost all the one year old fish were found between Div. 1A and Div. B, and as in 2023 a peak of recruitment was found in 1D and 1F (Fig. 10).

Different trends are observed when we look at the different division and offshore vs inshore. The recruitment offshore fluctuated since the good 2011 and 2013 year-classes. In 2011, it peaked in North Division 1A and Inshore, and in 2013, in South 1A and 1B. In 2014, the recruitment decreased in all divisions, and since then it increased, peaking in 2017. Then it dropped until 2019. In 2023, remains almost stable in 1A and 1CD, and it slightly decreased in 1B. (Fig. 11). More than 73 % of the one year old fish was found in the off shore areas (Fig.12).

Generally, there is a steep decline between abundance at age 1 and age 2 and 3+ , but in 2023, abundance age 2 is higher than age 1, then we observe a decline in the rest of ages(Fig. 13).

#### *Cod (*Gadus morhua*)*

The Atlantic cod (*Gadus morhua*) stock complex in Greenland is considered to be composed of primarily three different stock components; inshore cod, West Greenland cod and East Greenland/Iceland offshore cod. **Inshore cod** are believed to be relatively stationary, as tagging experiments showed that most (82-86 %) of the cod recaptured were found in the same area as tagged (Hovgård and Christensen 1990). West Greenland offshore cod that historically has been spawning along the banks of the West Greenland's coast (Wieland and Hovgaard 2002, Therkildsen et al. 2013). Larvae from the East Greenland/Iceland cod in some years drift with the current to West Greenland and gradually moves to East Greenland before reaching maturity. The 2016 survey indicated a major decline in the offshore cod stock in West Greenland (NAFO 1A-1E) with 80% in abundance and 86% in biomass compared to 2015 and the index and this was further confirmed in 2017 and 2018. However, the 2019 index is by far the highest observed in the timeseries. In 2019, two hauls provided almost 90% of the total biomass and 75 % of the total abundance. In 2020, the index returned to the levels observed prior to 2019 and the 2022 and 2023 is close to pre 2016. Length frequencies for west Greenland is given in figure 15. For more information on cod, see the ICES Report of the North-Western Working Group (Anon., 2022)

#### *Demersal Redfish (*Sebastes* sp.) combined.*

Two species of redfish are common in the area, golden redfish, *Sebastes norvegicus* and deep-sea redfish *Sebastes mentella*. Both the East Greenland and West Greenland shelf (1AB) are known nursery grounds for redfish. However, the distinction between the species and the normal dominance of recruits in the survey, has had the effect that in some years redfish were classified as *Sebastes* sp. (prior to 2007). After 2007 redfish

smaller than approximately ~18 cm has been classified as juvenile redfish *Sebastes sp.* and larger redfish are classified on a species level (table 10-15, figure 4b-d and 16a-c). In East Greenland the index was not evaluated in 2017 due to the low number of stations and lag of stations in the deeper strata and no survey was conducted in 2018 and 2019. In both East and West Greenland the abundance index is higher in 2022 and 2023 (figure 1a)

The combined golden redfish deep-sea redfish biomass in West Greenland gradually increased from 2005 to 2016, but decreased thereafter. However, the indices are about one order of magnitude lower than in East Greenland (fig 4a). The indices for redfish is often somewhat uncertain with a single or few hauls provide the majority of the annual biomass estimate. The increasing biomass observed in West Greenland during a period of decreasing or failing recruitment could be related to either connection with the stocks in East Greenland or perhaps increased survival of redfish since the implementation of sorting grids in the shrimp-fishery in 2002. Tow densities by haul reveal an almost continuous distribution of both species from East to West around Cape Farewell (fig 23-25). For further information on redfish in East Greenland see the ICES Report of the North-Western Working Group (Anon., 2022). The combined species abundance index decreased substantially from 1992 to 2019. However, since 2020 a new yearclass can be identified annually in the surveys returning the abundance indices to a level not observed since the beginning of the 1990's.

#### *Redfish recruitment.*

Annual growth increments of 4 cm are indicated by repeatedly pronounced peaks in length compositions at 7-8 cm and around 12 cm probably corresponding to age 1 and 2 (Nedreaas, 1990). In East Greenland, the survey has revealed a substantial decrease in the abundance index from 2009-2013 with very few small (7-20 cm) redfish in the survey until 2016. In West Greenland, the high numbers of redfish in the survey in the 1990's were mainly small redfish concentrated in division 1AS and 1B (fig 4a). The decreasing numbers of recruits continued in both East Greenland and West Greenland from 2008 with an almost complete lack of recruits (7-20cm) from 2011 to 2019. However, since 2020 new annual yearclasses can be found in surveys in both West Greenland and off East Greenland (fig 4b and 15a). The new yearclasses are mainly found in divisions 1AB and along the shelf in East Greenland Figure 23.

#### *Deep-sea redfish S. mentella*

In East Greenland, the deep-sea redfish abundance decreased substantially from 2008 to 2016, but a gradual shift in the length distribution from around 18-30 to 30-45 cm limited the decrease in the biomass index until 2016. The 2020 and 2022 biomass estimate was the lowest recorded, indicating that the decreasing trend from 2008 to 2016 has continued in the years without survey (fig 4c).

In West Greenland, the abundance of deep-sea redfish increased until 2011 and gradually decreased thereafter (fig 4c). Higher indices were observed 2016, but these were caused by a single haul in division 1D of large redfish between 25 and 40 cm. Regarding the 2016 and 2019 as outlier observations the overall trend in both abundance and biomass indices have been decreasing at least since 2012. However length frequencies in 2023 indicate that the recent recruitment of juvenile redfish are deep-sea redfish (figure 16b).

#### *Golden Redfish S. Norvegicus*

In East Greenland, the abundance index increased substantially in 2011 (juvenile category growing in to species classified mainly as Golden redfish category) but gradually decreased thereafter. The biomass index for golden redfish remained stable from 2010 to 2016 and remained higher level from 2011 to 2016. (fig 4d). The 2020 to 2023 biomass and abundance indices was however lower level.

In West Greenland, the golden redfish biomass has remained low since 2006 (table 15 and fig 4d). New yearclasses of golden redfish have not been observed for almost two decades (figure 16c).

#### *American plaice (Hippoglossoides platessoides).*

In West Greenland, American plaice is common in all divisions (table 16, 17 and figure 26). The biomass and

abundance indices have fluctuated substantially in recent years, but the general trend has been increasing both prior to and after the gear change (table 16, 17 and figure 5). Clear modes can be found at 5 and 15 cm indicating new incoming year-classes and individuals larger than 45 cm are rarely seen in Greenland (figure. 17). The highest concentrations are mainly found in West Greenland (figure 26). In East-Greenland, both abundance and biomass indices are much lower on the shallow parts of the East Greenlandic shelf.

#### *Atlantic wolffish (Anarhichas lupus)*

Atlantic wolffish is common in all divisions, in both East and West Greenland (figure 27). Previously Atlantic wolffish had its main distribution south of 68°N, but it has shifted further north since the beginning of the time series (table 18, 19 and figure 6). Although the abundance and biomass indices tends to have extreme values in some years, the underlying trends has been increasing in West Greenland, since the beginning of the time series. The uncalibrated trawl indices before and after the gearchange seems well connected. The 2018 and 2019 indices based on the chartered vessels are close to the latest Pâmiut and the charter vessel indices. The most recent abundance and biomass indices at East Greenland were significantly higher than observed in 2016 (figure 6). The updated in The length distribution reveals the dominance of smaller fish (figure. 18).

#### *Spotted wolffish (Anarhichas minor)*

Spotted wolffish are common in all divisions in both East and West Greenland, inshore and offshore. Abundance and biomass indices been in an increasing trend throughout the time series and the non-calibrated (gearchange) indices seems well connected (Table 20, 21 and figure 7). For spotted wolffish, the 2018 and 2019 indices based on the chartered vessels are also close to the latest Pâmiut indices. The length distribution ranges from 10-135 cm and modes at 13 and 100 cm likely represents one-year old recruits and individuals at  $L_{max}$  (figure 19). Updated indices for East Greenland also show a more or less stable abundance and a slightly decreasing biomass index (figure 7). Trawn densities of abundance is high along the west Greenland shelf from south to north but the biomass is concentrated in south west Greenland indicating that recruits and juvenile individuals are mainly found in North-west Greenland (figure 28).

#### *Thorny skate (Amblyraja radiata)*

In West Greenland, thorny skate is common in all divisions. Abundance (Table 22) and biomass (table 23) indices have increased throughout the time series. The non-calibrated indices before and after the gearchange seems well connected both in order of magnitude and trend (figure 8). Thorny skate indices based on the chartered vessels are also close to the latest Pâmiut time series and the new Tarajoq timeseries. Although  $L_{max}$  for thorny skates is reported to be more than 100 cm, it has been suggested that North American thorny skate grows to larger body size than East Atlantic individuals. Since individuals larger than 55 cm are rarely seen in Greenland waters and all individuals about 50 cm are fully mature, it seems likely that thorny skates in Greenland resemble East Atlantic stocks. During the most recent years, thorny skate length distributions have revealed clear modes at 10-15 cm and 35-50 cm probably corresponding to recruits and overlapping year-classes of adult individual (figure 20). Recruits and juvenile individuals are mainly found in North-west Greenland and the northern part of East Greenland (figure 29).

#### *Polar cod (Boreogadus saida)*

Polar cod is a small ecosystem important arctic cod fish, with a distribution that is highly connected to sea ice and glacier ice in the fjords. Length frequencies is given in figure 20. Polar cod is mainly found in North West Greenland (figure 30).

## Discussion

Catchability is set at 1 for all species. However, since swept area is calculated for the trawl excluding doors and bridles, catchability may be higher than 1 for some species and below 1 for other species, implying that both biomass and abundance should be regarded as index values only, not absolute values.

Index changes from the end of the 1990's to 2001 for species related to shallow water and banks (50-150m)

could reflect better coverage of these depths during the past decade. Changes from 2003 to 2004 could be influenced with the trawl door update from Greenland perfect to injector and may be species dependent, as no calibration experiments were made prior to the change. Index changes from 2004 to 2005 could be related to species specific data quality in the calibration experiments. If ignoring the calibration factors, the indices for most species seems better connected, indicating that there is little reason to calibrate in order to compare the time series. Indeed, even for Greenland halibut the length-dependent calibration factor has a 1:1 value around 12 cm which constitutes 80-90% of the individuals caught every year. Therefore, for the Greenland halibut abundance indices it matters little whether calibrating or not. Likewise, the tow most recent index updates based on the chartered vessels seems well connected to the timeseries from 2005-2017 obtained with the good old research vessel Pâmiut (RIP).

Since the main purpose of the survey is to evaluate the biomass of northern shrimp and the effort is concentrated in areas and depths where the commercial shrimp trawling is taking place, especially on the northern slopes of the bank Store Hellefiskebanke (67°50N 55°00W) and in the inshore area Disko Bay. As Store Hellefiskebanke and Disko Bay are important nursery areas for Greenland halibut and redfish, as well as other important species (Smidt, 1969; Tåning, 1949) it is likely, that the abundance estimates of the survey reflects the juvenile stock situation of these species.

### References

- Anon., 2016. Report of the North-Western Working Group (NWWG). *ICES CM 2016*.
- Burmeister, A. and Rigét F. The West Greenland trawl for *Pandalus borealis*, 2018, with reference to earlier results. NAFO Scientific Research Document 18/055.
- Cochran, W. G. 1977: Sampling Techniques, Third edition, Wiley & Sons.
- Kingsley, M.C.S., P. Kannevorff and D.M. Carlsson. 2004. Buffered random sampling: a sequential inhibited spatial point process applied to sampling in trawl survey for northern shrimp *Pandalus borealis* in West Greenland waters. *ICES J. Mar. Sci.* 61:12-24.
- Nedreaas, K. 1980: Age determination of Northeast Atlantic *Sebastes* species. *J. Cons. int.Mer.* 47: 47: 208-230.
- Nogueira, A. and Treble, M. A. 2020. Comparison of vessels used and survey timing for the 1CD and 0A-South deep-water surveys and the 1A-F west Greenland shelf surveys. NAFO SCR 20/15, Ser. No. N7060. 45 pp.
- Nogueira, A, Christiansen H. and Hedges K. Comparison of vessels used for the Greenland halibut shallow fish and shrimp survey in NAFO Division 1A-F. NAFO Scientific Research Document 23/032.
- Rosing, M.& K. Wieland (2005): Preliminary results from shrimp trawl calibration experiments off West Greenland (2004, 2005) with notes on encountered design/analyses problems. NAFO SCR Doc. 05/92.
- Smidt, E.L.B., 1969: The Greenland Halibut *Reinhardtius hippoglossoides* (Walb.), Biology and Exploitation in the Greenland Waters. *Meddelelser fra Danmarks Fiskeri- og Havundersøgelser*, N.S.,6: 79-148.
- Sünksen, K. 2007: Discarded by-catch in shrimp fisheries in Greenlandic offshore waters 2006-2007. NAFO SCR Doc. 07/88
- Tåning, Å.V., 1949. On the breeding places and abundance of the redfish (*Sebastes*) in the North Atlantic. *Ibid.* Journ. Cons. Vol.16 No.1: 85-96.
- Wieland, K.,& M. Storr-Paulsen, 2006: Effect of tow duration on catch rates and mean length of Northern shrimp (*Pandalus borealis*) and Greenland halibut (*Reinhardtius hippoglossoides*) in the West Greenland Bottom Trawl Survey. *Fish. Res.* 78: 276-285.



**Table 1.** The survey area (km<sup>2</sup>) in the Greenland Shrimp and Fish Survey in West Greenland (NAFO 1A-F) and East Greenland (ICES 14b).

<b>West Greenland</b>							
Area	Depthstrata						Total
	<100	100-150	150-200	200-300	300-400	400-600	
1A	3039	5220					8259
1B	11346	4966					16312
1C	4183	8169					12351
1D	4136	1538					5673
1E	494	2721					3215
1F	1497	5248					6745
C0				903	2179	1154	4236
I1			407	1963	2441	1499	6310
I2			419	815	1085	1338	3658
U1			2486	4633	4785	5129	17033
U2				6710	8481	7994	23185
U3			2012	3017	1675	2710	9413
W1			2873	6099	7520	816	17307
W2			1674	2612	1741	915	6941
W3			2122	4725	2085	2994	11926
W4			4119	1818	821	1961	8719
W5			3001	3648	1950	3021	11620
W6			1206	2006	1585	1234	6031
W7			2442	891	265	317	3915
W8			424	567	405	718	2114
W9			1711	938	516	430	3595
All strata	24695	27861	24895	41344	37534	32230	188559

<b>East Greenland</b>				
Area	Depthstrata			Total
	0001-0200	0201-0400	0401-0600	
Q1	217	35445	6975	42637
Q2	93	7657	1246	8996
Q3	3363	22547	9830	35740
Q4	1337	7770	2054	11161
Q5	469	2785	1819	5073
Q6	6307	6130	2063	14500
All strata				118107

**Table 2.** Numbers of valid hauls in West Greenland, since 1988. 1AX=Disko Bay. 0A= The West-Greenlandic shelf part in Canadian waters. (- area included in neighbour strata).

Year	West Greenland										Total	Vessel	Gear
	0A	1AN	1AS	1AX	1BN	1BS	1C	1D	1E	1F			
1990		29	63	*	68	17	35	16	*	*	228	Pa	SK30
1991		18	39	41	44	18	11	16	*	*	187	Pa	SK30
1992		20	33	39	36	8	18	18	11	15	198	Pa	SK30
1993		16	22	31	39	10	21	15	12	13	179	Pa	SK30
1994		16	33	27	49	9	23	8	9	9	183	Pa	SK30
1995		17	33	33	48	13	29	13	14	11	211	Pa	SK30
1996		18	20	33	46	11	29	12	9	11	189	Pa	SK30
1997		17	33	34	47	9	32	12	12	19	215	Pa	SK30
1998		10	34	33	66	14	27	19	14	14	231	Pa	SK30
1999		10	40	34	63	18	33	16	14	17	245	Pa	SK30
2000		8	25	23	45	17	37	23	14	29	221	Pa	SK30
2001		9	28	23	59	16	36	24	15	26	236	Pa	SK30
2002		2	26	22	68	12	32	18	20	27	227	Pa	SK30
2003		11	21	19	51	12	30	18	15	22	199	Pa	SK30
2004		15	25	14	41	14	24	22	20	34	209	Pa	SK30
2005	6	20	30	16	45	10	26	19	23	23	212	Pa	CO26
2006	5	26	40	21	49	9	27	20	21	31	244	Pa	CO26
2007	8	18	38	18	47	9	27	27	31	39	254	Pa	CO26
2008	6	16	38	16	53	7	28	23	25	46	252	Pa	CO26
2009	8	21	31	24	60	13	28	22	24	48	271	Pa	CO26
2010	10	26	44	25	65	11	30	23	24	40	289	Pa	CO26
2011	-	17	31	26	54	9	24	18	12	25	216	Pa	CO26
2012	-	18	34	21	52	12	21	18	18	26	220	Pa	CO26
2013	4	19	37	17	44	8	20	13	21	28	211	Pa	CO26
2014	-	21	36	21	47	10	19	17	23	32	226	Pa	CO26
2015	-	24	29	17	42	7	24	22	20	36	221	Pa	CO26
2016	-	18	29	12	32	6	27	14	19	36	193	Pa	CO26
2017	3	27	42	30	43	9	25	18	25	35	257	Pa	CO26
2018	-	20	38	20	33	9	26	23	20	35	244	Sj	CO26
2019	-	26	43	17	30	6	20	18	14	24	198	HM	CO26
2020	-	25	37	22	37	14	29	21	23	43	251	HM	CO26
2021	-	-	-	-	-	-	-	-	-	-	-	No	survey
2022	-	38	61	25	64	20	42	23	28	30	331	TA	CO26
2023	-	30	33	25	34	24	37	29	31	35	278	TA	CO26

Note.

2005. Strata 1A 50-100 no stations - area included in 1A 100-150.

2006. Strata 1C 50-100 no stations - area included in 1C 100-150.

2007. Strata 1C 50-100 no stations - area included in 1C 100-150.

2008. All strata surveyed.

2009. Strata 1A:50-100 no stations - area included in 1A 100-150.

2010. Strata 1A:50-100, 1A:100-150 no stations - area included in U1 150-200.

2011. Strata W1:400-600, C0:200-300, C0:300-400, C0:400-600 no stations - included in W1 300-400.

2012. Strata C0:200-300, C0:300-400, C0:400-600 no stations - area included in W1 300-400.

2013. Strata C0:400-600 no stations - included in C0 300-400. Strata W9:400-600 no stations - included in W9 300-400.

2014. Strata C0:200-300, C0:300-400, C0:400-600 no stations - area included in W3 equivalent depth strata.

2015. Strata C0:200-300, C0:300-400, C0:400-600 no stations - area included in W3 equivalent depth strata. W1:400-600 included in W1 300-400. Northern area restricted to Eastern shelf due to sea ice.

2016. Strata C0:200-300, C0:300-400, C0:400-600 no stations - area included in W3 equivalent depth strata.

2017. Strata C0:400-600 no stations - included in C0 300-400. Strata W1:400-600 no stations - included in W1 300-400.

2018. Strata C0:200-300, C0:300-400, C0:400-600 no stations - area included in W3 equivalent depth strata. W1:400-600 included in W1:200-300.

2019. Strata C0:200-300, C0:300-400, C0:400-600 no stations – area included in W3 equivalent depth strata. W1:400-600 included in W1:200-300.  
2021. No survey



**Table 2** - continued. Numbers of valid hauls in East Greenland since 2007.

East Greenland									
Year	Q1	Q2	Q3	Q4	Q5	Q6	Total	Vessel	Gear
2007		5	12	9		9	35	Pa	CO26
2008	8	6	12	7	7	12	52	Pa	CO26
2009	21	12	26	19	6	13	97	Pa	CO26
2010	19	14	24	9	6	10	82	Pa	CO26
2011	20	11	21	12	7	14	85	Pa	CO26
2012	19	16	28	13	7	15	98	Pa	CO26
2013	25	12	22	14	5	14	92	Pa	CO26
2014	22	14	12	9	8	16	81	Pa	CO26
2015	26	11	24	12	8	14	95	Pa	CO26
2016	29	10	26	13	7	16	101	Pa	CO26
2017	2	4	7	6	6	11	36	Pa	CO26
2018	-	-	-	-	-	-	-		
2019	-	-	-	-	-	-	-		
2020	23	13	27	13	7	16	99	HM	CO26
2021	-	-	-	-	-	-	-		
2022	26	13	35	11	8	9	102	TA	CO26
2023	34	34	34	34	34	34	122	TA	CO26

**Note:**

2007 Survey startup year. Only 35 hauls. No results presented.

2008. Strata Q1,Q2,Q4:0-200 no stations - included Strata Q1,Q2,Q3:200-400.

2009. Strata Q1:0-200 m no stations - area included in Q1:200-400.

2010. Strata Q1:0-200 m no stations - area included in Q1:200-400.

2011. Strata Q1:0-200 m no stations - area included in Q1:200-400.

2012. Strata Q1:0-200 m no stations - area included in Q1:200-400.

2013. Strata Q1:0-200 m no stations - area included in Q1:200-400. Strata Q5:0-200 m no stations - included in Q4:0-200.

2014. Strata Q1:0-200 m no stations - area included in Q1:200-400. Strata Q3:0-200 included in Q4:0-200 (COD Q3:200-400.)

2015. Strata Q1:0-200 m no stations - area included in Q1:200-400. Stations in Icelandic EEZ included under strata in Grl.

2016. Strata Q1:0-200 m no stations - area included in Q1:200-400.

2017. Insufficient survey coverage for most species.

2018. No survey.

2019. No survey.

**2020. Vessel Helga Maria**

2021. No survey

2022. RV Tarajoq.

**Table 3.** Preliminary calibration factors  $tTT$  to adjust the Cosmos trawl catches to the former Skjervoy trawl standard. For Greenland halibut and American plaice the conversion were length dependent and for those species  $x$  in the equations represents the individual fish length. (Not used in the indices)

Fishspecies	Greenland halibut	Redfish	American plaice	Atlantic wolffish	Spotted wolffish	Cod	Thorny skate
Conversion factor	$0.0404x+0.6527$	2.4	$-0.0825x + 5.3307$	2.3	2.3	1.78	5.1
Trawl size factor	1/1.1516	1/1.1516	1/1.1516	1/1.1516	1/1.1516	1/1.1516	1/1.1516
Final factor	$0.035x+0.567$	2.0	$-0.072x + 4.629$	2.0	2.0	1.5	4.4

**Table 4.** Greenland halibut *Reinhardtius hippoglossoides* abundance indices (millions).

Year	OA	1AN	1AS	1AX	1BN	1BS	1C	1D	1E	1F	West	CI	East	
1992		50.7	8.2	96.7	231.5	1.5	1.2	0.8	0.6	0.0	391.2	27		
1993		29.1	24.3	34.0	152.6	9.8	4.3	4.6	0.4	0.5	263.5	28		
1994		22.9	35.2	63.0	130.7	10.0	18.1	2.4	0.1	0.4	282.8	22		
1995		39.5	28.9	89.4	98.9	18.3	12.2	5.7	0.1	0.3	293.4	32		
1996		92.6	13.7	102.5	265.9	11.8	14.0	10.7	0.2	0.4	511.7	25		
1997		41.3	17.5	112.1	97.6	2.2	13.0	0.9	0.1	0.3	285.0	22		
1998		78.5	30.4	209.6	47.2	23.3	7.2	3.6	1.4	0.6	401.6	29		
1999		100.8	58.2	95.4	91.0	5.8	5.3	7.7	1.3	0.9	366.3	35		
2000		81.7	19.3	172.8	126.7	4.1	4.8	6.7	0.1	0.6	416.8	30		
2001		145.9	97.9	223.7	111.5	1.7	4.8	2.6	0.7	1.6	590.2	28		
2002		78.0	75.2	148.1	42.5	2.7	6.2	6.5	0.6	1.3	360.9	38		
2003		154.6	37.7	227.0	116.7	2.3	2.0	2.4	0.1	1.0	543.8	36		
2004		154.8	20.6	199.1	84.8	2.4	2.9	2.8	0.1	0.4	468.0	34		
		New survey gear introduced										e cv	cv	
2005	3.3	177.5	51.6	186.5	202.0	5.3	9.1	1.9	1.1	0.5	638.8	12		
2006	14.1	110.5	69.9	96.9	198.6	4.2	24.6	0.8	0.0	0.3	520.0	11		
2007	10.5	103.1	75.3	128.5	154.4	2.2	37.9	0.3	1.2	0.4	513.8	13	-	
2008	13.2	184.2	106.5	64.6	88.6	0.7	0.6	0.9	0.3	0.3	459.9	12	3.0	53
2009	8.0	132.8	75.3	72.9	119.6	6.9	0.7	0.9	0.3	0.1	417.5	8	4.1	120
2010	9.1	154.5	117.7	123.3	115.9	4.5	0.7	1.2	0.1	0.1	527.1	9	3.0	43
2011	-	318.8	111.6	230.7	93.4	8.9	1.1	0.9	0	0.2	765.6	16	2.9	37
2012	-	80.2	48.8	105.9	52.3	5.0	0.4	0.1	0	0.1	292.8	8	1.7	46
2013	1.0	148.0	212.0	188.0	145.0	11.0	5.0	0.0	0.0	0.0	711.0	16	1.7	38
2014	-	79.1	117.0	103.7	32.6	1.7	1.6	0.3	0.6	0	336.1	15	0.8	25
2015	-	77.7	101.7	84.1	131.1	3.6	2.4	1.5	0.2	0.2	402.4	11	0.5	32
2016	-	99.9	134.3	120.1	108.1	5.8	4.5	1.3	0.2	0.3	474.5	16	1.1	38
2017	40.9	82	187.7	113.2	272.9	5.5	0.7	2.1	0.1	0.1	705.3	14	-	-
2018	-	66.6	62.9	95.3	95.1	46.7	3.1	0.6	0.9	0.2	371.4	15	-	-
2019	-	99.1	61	81.7	83.7	21.8	2	0.3	0.1	0.3	350.1	16	-	-
2020		115.0	151.6	138.3	59.4	8.8	0.8	5.0	0.4	0.1	479.5	8	1.5	46
2021														
2022		111.0	99.1	126.0	55.4	7.0	2.3	1.5	0.5	0.2	403.1	9	1.5	37
2023		324.3	70.3	129.5	35.6	1.1	1.6	0.4	0.8	0.2	563.8	20	1.7	25

**Table 5.** Greenland halibut *Reinhardtius hippoglossoides* biomass indices (tons).

Year	0A	1AN	1AS	1AX	1BN	1BS	1C	1D	1E	1F	West	CI	East	
1992		3516	785	4992	4203	402	206	97	48	0	14250	22		
1993		2483	1286	2507	4255	747	595	539	333	60	12804	27		
1994		2007	1697	3598	4748	1665	1458	91	10	25	15199	26		
1995		4367	1291	5786	2567	825	971	502	12	45	16365	51		
1996		3682	1294	8593	5496	439	1248	899	9	118	21778	22		
1997		4972	1746	6456	4929	421	1754	180	25	84	20567	29		
1998		7025	4976	11874	2821	1724	863	275	117	278	29955	35		
1999		10205	6025	8060	5224	555	778	261	48	318	31473	44		
2000		3411	1713	9537	3985	454	692	567	38	280	20676	30		
2001		8433	2478	10161	3802	278	1208	289	33	443	27126	32		
2002		6158	2067	9070	3108	779	737	670	39	402	23055	40		
2003		8297	3399	16556	5693	478	589	297	4	355	35668	28		
2004		15182	2079	28229	11755	1147	420	319	2	201	59332	36		
		New survey gear introduced										ecv	Cv	
2005	421	22894	7010	22580	17150	574	1129	347	263	412	72780	12		
2006	519	15179	4516	20246	13797	519	6693	93	0	206	61769	12		
2007	769	11603	5666	13137	6950	163	5920	3	82	246	44539	18	-	
2008	402	19559	4417	16422	7822	147	302	120	59	179	49429	13	4850	40
2009	229	21764	2634	19902	7047	478	324	164	16	25	52584	20	4454	100
2010	489	25880	7071	17559	8658	599	54	320	1	58	60688	11	5729	33
2011	-	18213	6778	23977	13945	640	364	49	0	14	64547	10	3825	34
2012	-	10331	4327	16168	9194	1475	225	7	4	81	41813	7	2439	51
2013	210	13661	12510	15103	11508	689	812	3	95	105	54695	9	2664	28
2014	-	8577	7388	11463	6014	942	829	45	111	9	35377	12	1611	28
2015	-	13651	7272	13180	12716	461	287	200	13	183	47962	15	1351	30
2016	-	14638	7567	11772	4799	685	270	78	42	246	40098	12	1181	39
2017	1378	14532	13377	12040	9015	804	139	483	15	44	51827	13	-	-
2018	-	10565	4520	17355	6894	3758	301	137	98	107	43735	11	-	-
2019	-	22249	7254	11602	8129	3446	695	155	23	137	53690	12	-	-
2020	-	13337	10632	15130	9482	1795	200	576	83	51	51284	9	2058	47
2021														
2022		10502	7200	21052	9799	1511	1083	313	59	618	52138	9	2747	47
2023		31084	5904	18945	9164	249	775	47	126	351	66645	11	3334	27

**Table 6.** Cod *Gadus morhua* abundance indices (millions).

Year	0A	1AN	1AS	1AX	1BN	1BS	1C	1D	1E	1F	West	CI	East	
1991	0.0	0.0	0.0	0.0	0.0	0.0	0.3	0.5			0.8	51		
1992	0.0	0.0	0.0	0.0	0.0	0.0	0.2	0.3	0.0	0.0	0.6	49		
1993	0.0	0.0	0.0	0.0	0.0	0.0	0.0	0.1	0.3	0.0	0.5	66		
1994	0.0	0.0	0.0	0.0	0.0	0.0	0.1	0.0	0.0	0.0	0.1	47		
1995	0.0	0.0	0.0	0.0	0.0	0.0	0.4	0.0	0.1	0.0	0.6	55		
1996	0.0	0.0	0.0	0.0	0.0	0.0	0.0	0.1	0.1	0.1	0.3	54		
1997	0.0	0.0	0.0	0.0	0.0	0.0	0.0	0.0	0.0	0.0	0.0	68		
1998	0.0	0.0	0.0	0.0	0.0	0.0	0.0	0.0	0.0	0.0	0.1	54		
1999	0.0	0.0	0.0	0.0	0.1	0.0	0.0	0.0	0.0	0.0	0.2	29		
2000	0.0	0.0	0.2	0.4	0.3	0.2	0.1	0.1	0.0	0.2	1.3	23		
2001	0.0	0.0	0.0	0.0	0.2	0.1	0.1	0.4	0.3	0.3	1.5	26		
2002	0.0	0.0	0.0	0.0	0.1	0.1	0.1	3.3	0.1	0.5	4.2	50		
2003	0.0	0.0	0.1	0.4	1.4	0.0	0.4	0.7	0.2	0.2	3.4	22		
2004	0.0	0.0	0.0	0.2	0.0	0.1	0.4	2.6	1.5	1.6	6.5	29		
	New survey gear introduced											cv	cv	
2005	0.1	0.0	0.0	0.1	0.7	0.1	1.8	4.8	6.8	94.1	108.7	52		
2006	0.5	0.0	0.2	0.2	2.8	1.4	2.5	16.5	3.3	46.3	73.8	27		
2007	0.7	0.0	1.0	0.3	2.5	0.7	7.1	3.0	2.6	38.1	56.1	46	-	
2008	1.2	0.1	0.7	0.1	2.4	1.7	4.1	9.5	11.9	21.7	53.4	23	31.5	22
2009	0.9	0.0	0.8	0.1	3.2	1.0	3.2	2.8	1.4	1.7	15.1	11	54.7	15
2010	0.3	0.1	0.6	0.0	1.7	1.1	2.7	8.2	2.5	6.1	23.4	24	45.3	51
2011	-	0.0	3.4	3.7	35.8	7.8	2.1	19.5	1.0	7.4	80.9	17	42.7	25
2012	-	1.1	3.8	3.5	10.0	1.0	3.3	1.2	27.1	20.3	71.1	39	22.7	21
2013	4.7	1.0	4.0	3.8	11.1	1.6	6.1	7.5	30.0	55.5	125.2	36	67.2	37
2014	-	2.4	4.2	0.4	4.4	1.3	78.9	2.5	16.5	20.6	131.0	57	35.4	49
2015	-	2.0	1.4	3.1	9.1	2.2	27.2	31.7	19.0	40.4	136.1	28	29.1	22
2016	-	0.5	3.9	0.5	2.6	0.7	10.9	1.6	3.3	4.5	28.4	22	23.7	19
2017	0.5	0.4	1.5	0.7	2.3	2.1	15.7	4.9	5.5	13	46.4	28	-	-
2018	-	0	1.7	0.4	0.6	9.5	5.3	8	6.4	6	5.3	14	-	-
2019	-	0.9	2.2	0.7	5	4.1	19.8	87.9	110.3	5.2	236.2	54	-	-
2020	-	0.5	0.5	0.2	6.5	4.0	3.7	2.0	6.0	22.0	45.3	28	36	19
2021	-													
2022	-	0.2	7.5	4.8	11.5	19.3	15.8	14.4	40.4	16.3	130.2	22	46.6	18
2023	0	0.4	3.1	1.4	16.4	4.1	24.6	2.7	11.3	42.7	106.8	30	46.7	22

**Table 7.** Cod *Gadus morhua* biomass indices (tons). () incomplete coverage of survey area.

Year	0A	1AN	1AS	1AX	1BN	1BS	1C	1D	1E	1F	West	CI	East		
1990		2	13	*	75	3	83	9005	*	*	(9180)	65			
1991		0	0	7	2	15	151	310	*	*	(485)	44			
1992		0	0	3	20	34	75	112	0	2	246	46			
1993		0	0	2	0	5	22	39	113	5	186	68			
1994		0	3	0	0	9	38	0	1	0	51	46			
1995		0	0	0	5	1	120	23	3	4	155	63			
1996		0	0	0	0	0	15	23	24	44	107	50			
1997		0	0	0	0	2	53	0	0	0	55	76			
1998		0	0	0	1	0	0	47	50	3	101	56			
1999		0	1	5	23	5	1	17	1	0	53	47			
2000		0	51	99	76	54	21	9	2	46	357	23			
2001		0	0	15	125	30	56	178	98	100	603	23			
2002		0	0	13	54	74	41	1489	42	150	1863	46			
2003		0	18	111	315	8	264	453	118	46	1332	26			
2004		0	0	496	46	7	176	680	685	305	2394	28			
					New survey gear introduced								cv		cv
2005	38	0	22	45	320	19	449	1077	1170	60546	63684	71			
2006	114	0	40	22	578	74	471	5513	536	19874	27221	32			
2007	247	13	317	56	711	121	1502	514	541	26843	30865	54	-		
2008	421	99	227	46	1218	794	923	1730	3321	19702	28481	37	47864		
2009	212	0	184	42	1046	199	688	453	282	499	3604	13	58141		
2010	183	38	215	7	821	144	573	2417	835	2899	8133	31	110656		
2011	-	1	537	726	7468	1493	398	3963	196	3948	18730	16	81138		
2012	-	194	1061	841	3000	313	1226	447	14104	15911	37098	39	64421		
2013	2446	294	1026	1287	3443	447	1871	4361	19015	51622	85812	37	168771		
2014	-	709	1644	286	1813	492	56061	2511	21714	27755	112984	50	153807		
2015	-	1076	429	1958	4103	353	19705	33169	27532	60282	148606	30	104806		
2016	-	319	1460	477	1068	106	9039	1345	2523	4755	21092	25	89413		
2017	697	205	428	641	772	483	14110	3032	3975	8401	32744	39	-		
2018	-	513	126	445	1770	338	2369	2796	2317	8498	19173	16	-		
2019	-	252	858	240	1128	650	7123	171005	82705	3869	267832	69	-		
2020		149	210	131	2035	789	1043	771	8696	24989	38814	33	92192		
2021															
2022		107	1389	1651	3279	7409	6888	6108	38222	14894	79948	31	115014		
2023	0	129	439	320	4440	1946	9867	3996	9966	45103	76207	30	80275		



**Table 8.** Redfish species combined. all sizes (*Sebastes sp.*) abundance indices (millions).

Year	0A	1AN	1AS	1AX	1BN	1BS	1C	1D	1E	1F	West	CI	East
1992		1	146	9	1006	187	69	34	6	4	1462	32	
1993		4	210	17	361	22	157	182	97	520	1568	69	
1994		12	187	12	1573	225	273	85	10	84	2461	26	
1995		1	67	11	559	33	183	93	5	5	957	23	
1996		1	8	8	1688	59	124	63	11	54	2017	29	
1997		5	43	7	348	58	156	57	23	22	719	24	
1998		1	24	20	236	15	115	71	10	32	522	24	
1999		2	69	9	287	11	11	61	4	23	574	21	
2000		0	27	6	27	32	28	10	18	159	165	23	
2001		2	77	3	25	15	20	12	1	180	183	60	
2002		1	23	1	50	84	43	44	2	10	257	27	
2003		2	45	2	210	32	79	25	2	26	423	23	
2004		2	11	1	52	39	47	30	2	69	253	37	
					New survey gear introduced							cv	cv
2005	184	1	19	1	73	79	77	25	12	80	551	-	
2006	27	7	25	1	110	52	83	16	3	11	334	-	
2007	97	2	37	0	128	34	49	5	3	17	371	-	-
2008	99	2	40	0	121	33	24	3	2	11	334	-	1847
2009	37	2	29	0	115	26	12	1	2	9	234	-	1988
2010	27	6	27	0	69	42	23	8	3	8	213	-	1566
2011	-	10	23	1	121	18	31	13	1	9	225	-	2517
2012	-	7	10	0	42	13	20	10	2	16	120	-	1018
2013	12	2	10	0	29	4	30	6	44	7	145	-	1075
2014	-	1	3	0	23	5	3	39	20	3	96	-	559
2015	-	1	2	0	13	1	11	39	8	7	82	-	762
2016	-	1	1	0	4	4	15	199	34	6	265	-	429
2017	1	0	1	0	5	2	11	10	5	5	39	-	-
2018	-	1	0	0	9	0	15	5	21	20	71	-	-
2019	-	0	0	0	4	9	6	9	1	5	35	-	-
2020		1	60	0	135	14	15	10	5	16	256	-	333
2021													
2022		8	205	29	1368	96	41	16	5	7	1776	-	1166
2023		3	45	26	1722	47	25	3	6	12	1889	-	1006

**Table 9.** Redfish species combined. all sizes *Sebastes sp.* biomass indices (tons).

Year	0A	1AN	1AS	1AX	1BN	1BS	1C	1D	1E	1F	West	CI	East
1992		69	18117	437	13423	2832	1576	1124	169	147	37894	43	
1993		195	4994	710	6420	300	1549	3835	1923	2138	22065	38	
1994		590	5076	538	16064	1986	3886	995	179	1272	30586	24	
1995		52	1585	775	5029	869	2963	1952	358	123	13705	22	
1996		18	117	782	12178	1694	2552	1980	304	1788	21413	28	
1997		599	1481	337	4913	1597	6766	1901	1099	1229	19922	31	
1998		39	1467	1423	6193	2130	3274	1953	606	1198	18283	22	
1999		164	4021	742	5596	999	2742	2976	207	1124	18671	25	
2000		0	1790	793	1045	2185	2337	463	2411	1214	12237	36	
2001		192	5380	536	1746	1460	2637	1069	60	2256	15337	50	
2002		55	1917	397	2536	2386	1676	2654	272	998	12891	28	
2003		279	2886	702	6357	2319	6185	1918	187	2476	23308	32	
2004		369	462	368	2210	2274	2996	1679	101	1026	11486	41	
					New survey gear introduced							cv	cv
2005	3491	134	1378	665	3370	6974	6212	2751	1388	2771	29132		
2006	591	1129	2196	759	4427	2717	6213	959	557	2350	21897		
2007	3367	248	2172	153	6886	1499	5166	358	282	1778	21908	-	-
2008	2845	433	2221	210	7411	4007	2542	224	286	2585	22761	-	290666
2009	1696	356	2472	193	5496	3688	1951	293	335	1339	17819	-	318517
2010	1348	761	3363	910	4765	4193	3073	1043	369	1069	20895	-	336840
2011	-	1917	1536	1486	8362	3538	5377	4026	226	2397	28865	-	511700
2012	-	1382	1224	998	4380	2438	3560	1942	239	10341	26505	-	234650
2013	965	429	1684	553	6063	1077	7327	1269	23081	3178	45626	-	454592
2014	-	370	394	150	5241	1074	1092	11621	11017	2009	32969	-	206406
2015	-	276	548	1000	3458	427	2833	12477	4590	4771	30381	-	288118
2016	-	502	317	420	964	1514	4894	61617	41426	3373	115028	-	486768
2017	61	282	291	134	2489	291	4255	3308	3399	1822	16332	-	-
2018	-	498	158	136	3856	30	5305	2029	14000	10565	36577	-	-
2019	-	667	212	418	3662	3526	12024	3898	1004	3034	28444	-	-
2020		3	752	67	2955	3593	1349	164	1672	1282	11837	-	62259
2021													
2022		91	3688	795	28187	3591	6247	2337	4995	1477	51409	-	133635
2023		163	614	1115	24412	2116	4697	194	4701	3975	41987	-	113288

**Table 10.** Juvenile redfish < 20cm *Sebastes sp.* abundance indices (millions).

Year	0A	1AN	1AS	1AX	1BN	1BS	1C	1D	1E	1F	West	cv	East	cv
2006	26.7	6.4	19.5	0	107.1	47.1	75.8	14.4	1.6	7.3	305.8	16		
2007	94.7	0	28.2	0	121.8	32.5	45.2	4.7	2.4	13.6	343.3	15	952.5	26
2008	95.6	0.4	35.7	0	120.9	0.2	8.6	1.9	0.9	5.2	269.4	26	452.4	53
2009	34.8	0	14	0	110	1	4.4	0.5	1.2	3.7	169.6	24	953.8	28
2010	23.7	0	9.5	0	34.5	0	3.5	3.7	1.9	4.5	81.2	21	517.8	31
2011	0	0.2	14.7	0.1	74.9	0.8	0.4	2.4	0.4	0.4	94.1	23	102.3	61
2012	0	0	1.8	0	20.2	0.2	1	0.4	0.6	0.3	24.5	23	254.4	56
2013	4.5	0.1	3.1	0	18.4	0.3	2.1	1	0.1	0.2	29.7	17	46.8	36
2014	0	0	0.9	0	8.1	0.2	0.1	0.1	0.1	0.1	9.5	31	22.6	33
2015	0	0	0.2	0	4.2	0	0	0.7	0.1	0.1	5.3	36	20.6	52
2016	0	0	0.1	0	0.6	0	0.1	0.1	0.1	0.4	1.5	18	4.8	22
2017	0.3	0	0	0	2	0.3	0.2	0.4	0.3	1.9	5.6	19	-	-
2018	0	0.4	0	0	4.8	0.1	0.2	0.3	0.2	0.5	6.4	59	-	-
2019		0	0.1	0	0.5	0.1	0.3	0.2	0.1	1	2.2	28	-	-
2020		0.6	59.9	0.1	130.7	4.5	12	9.9	1.8	13.3	232.8	16	237.5	23
2021														
2022		8.1	204.9	29.4	1366.1	92.6	29.9	12.9	0.9	5.7	1750.4	16	901.7	18
2023	0	2.5	44.9	25.9	1716.4	42.8	11.8	2.5	2.9	6.8	1856.5	47	777.1	23

**Table 11.** Juvenile redfish <20cm *Sebastes sp.* biomass indices (tons).

Year	0A	1AN	1AS	1AX	1BN	1BS	1C	1D	1E	1F	West	cv	East	Cv
2006	480	651	1400	0	3340	2128	4483	741	113	1210	14546	18		
2007	2866	0	1449	0	4088	1132	4457	173	98	733	14996	16	195922	32
2008	2322	2	1665	0	5360	2	143	43	12	49	9598	29	9011	53
2009	1315	0	471	3	3569	34	152	9	25	89	5668	29	41341	63
2010	895	0	401	0	1598	0	105	155	71	148	3372	29	24135	31
2011	-	9	291	1	2639	45	20	86	26	16	3132	32	3781	56
2012	-	0	52	0	735	8	31	13	22	14	875	24	36705	79
2013	223	2	159	1	811	10	113	12	3	6	1340	21	1231	33
2014	-	0	22	0	227	7	4	3	4	2	268	28	596	26
2015	-	0	6	0	213	0	0	11	5	2	236	44	796	45
2016	-	0	3	0	15	0	0	3	2	7	31	33	329	30
2017	10	0	0	0	33	6	5	11	9	41	114	19	-	-
2018	-	378	0	0	122	3	6	10	8	17	544	72	-	-
2019		0	2	0	8	6	9	4	3	32	63	27	-	-
2020		3	546	1	1152	37	108	101	18	101	2066	17	3577	23
2021														
2022		91	3617	588	27557	3003	711	380	17	153	36116	13	17255	22
2023		93	524	941	23281	1765	457	74	55	117	27308	43	25767	27

**Table 12.** Deep-sea redfish *Sebastes mentella* abundance indices (millions).

Year	0A	1AN	1AS	1AX	1BN	1BS	1C	1D	1E	1F	West	cv	East	cv
2006	0	0.6	1.4	0.2	0.9	0.8	1.5	0.5	0.3	1.6	7.8	24		
2007	0.4	0	0.1	0.1	6.5	0	0.1	0.1	0.1	0.8	8.1	52	-	-
2008	0.9	1.4	3.6	0	2.2	31.6	13.6	0.4	0.2	2.2	56.2	56	1286,1	49
2009	0.7	1.5	13.7	0.1	3.9	23.4	7.7	0.5	0.1	4.1	55.7	45	894,7	29
2010	2.2	5.5	16.1	0	35.9	40.1	17.8	4	0.4	2.8	124.7	36	1017,8	36
2011	0	8.7	8.3	0	55.6	15.4	28.6	6.9	0.4	5.3	129.1	22	399,7	22
2012	0	6.4	6.8	0.2	19.8	12	16.1	8	1.4	4.1	74.7	10	305,3	27
2013	7	0.9	6.1	0.1	9.7	3.4	24.1	2.3	41.9	2.6	98.2	85	354,4	33
2014	0	0.4	2.1	0	13.1	4.8	1.5	37.5	18.6	1.8	79.7	25	171,6	25
2015	0	0.4	2	0.1	6.4	0.8	9.6	36	5.7	4.1	65.1	38	130,4	23
2016	0	0	0.6	0	3.1	4.1	14.7	197.3	24.5	4.4	248.8	77	188,2	67
2017	0.3	0.5	0.5	0	2	1.2	10.4	8.5	4.2	1.6	29.2	20	-	-
2018	0	0.3	0.1	0	2,4	0,1	14,1	5	19,4	18	59,4	52	-	-
2019	-	0,1	0,1	0	2,1	8,9	0,8	8,8	0,4	2,1	23,4	48	-	-
2020	-	0	0.4	0	3.8	9.8	2.8	0.3	2.6	1.9	21.7	34	24,4	16
2021	-													
2022	-	0	0	0	1,8	3,5	11	2,7	2,5	1,3	22,9	24	39,3	49
2023	-	0.4	0.1	0.4	5.2	4	12.4	0.9	1.8	3.4	28.5	21	122.2	25

**Table 13.** Deep-sea *Sebastes mentella* biomass indices (tons).

Year	0A	1AN	1AS	1AX	1BN	1BS	1C	1D	1E	1F	West	cv	East	cv
2006	10	169	66	82	279	268	542	66	40	489	2010	22		
2007	82	0	27	29	1592	0	8	29	16	315	2099	84		
2008	141	244	390	10	473	3859	2247	72	52	430	7916	49	247557	47
2009	77	238	1679	47	650	2891	1499	215	12	894	8202	38	236680	35
2010	138	606	1819	12	2346	3906	2358	622	79	589	12475	36	283924	36
2011	0	1290	1011	4	4127	3051	4355	1533	93	1330	16794	24	122949	26
2012	0	1041	840	356	1906	2024	2316	1441	155	999	11078	9	100268	29
2013	640	124	931	232	2768	807	5833	479	21213	910	33938	59	175527	50
2014	0	71	264	8	1949	991	379	10466	9559	838	24525	22	67613	24
2015	0	103	543	32	1031	181	2287	10302	2800	2104	19382	35	60598	28
2016	0	7	86	0	515	1138	4282	59250	15241	2311	82831	72	163748	79
2017	51	282	156	9	771	210	3174	2386	2772	735	10546	24	-	-
2018	-	95	91	6	940	18	4958	1638	12732	9073	29550	65	-	-
2019		35	20	33	528	3454	170	3606	219	1465	9530	49	-	-
2020		0	82	0	704	3460	909	63	1396	842	7456	35	18389	16
2021														
2022	-	0	0	6	216	506	4586	1588	2548	729	10178	28	33306	55
2023	-	28	18	51	626	316	4043	106	1628	1161	7978	27	25527	15

**Table 14.** Golden redfish *Sebastes norvegicus* abundance indices (millions).

Year	0A	1AN	1AS	1AX	1BN	1BS	1C	1D	1E	1F	West	cv	East	cv
2006	0.1	0.5	3.5	0.4	2.6	0.2	2.4	0.4	1.1	1.4	12.6	23		
2007	0.7	2.5	7	0.1	2.1	1	4.9	0.4	0.4	1.2	20.2	43	3.1	42
2008	1.4	0.3	0.4	0.1	1.3	0.1	0.7	0.3	0.4	3.5	8.5	25	108.0	29
2009	0.5	0.3	0.9	0.1	1.1	0.7	0.5	0.2	0.5	1.7	6.5	15	139.7	27
2010	0.4	0.3	1.1	0.4	0.7	0.9	0.7	0.3	0.7	0.5	5.9	17	78.1	38
2011	-	0.9	0.4	0.7	2.3	0.7	3.2	3.3	0.7	2.1	14.4	12	2015.1	36
2012	-	0.5	0.5	0.3	1.9	0.4	2	1.9	0.1	11.5	19	54	459.0	36
2013	0.3	0.6	0.8	0.1	2.1	0.4	2.4	3	3.5	3.6	17	15	716.3	35
2014	-	0.4	0.4	0	1.5	0.1	0.9	0.9	0.9	1.5	6.7	17	402.1	42
2015	-	0.2	0	0.4	1.8	0.2	0.8	2	2.5	3.1	11.1	19	610.7	37
2016	-	0.6	0.2	0.1	0.3	0.2	0.5	1.7	9.6	1.6	14.8	80	236.2	38
2017	0	0	0.1	0.1	0.8	0.1	0.7	0.6	0.5	1.5	4.4	11	-	
2018	-	0	0.1	0	1.5	0.1	0.3	0.2	0.9	1.7	4.7	18	-	
2019	-	0.4	0.2	0.1	1.2	0	4.5	0.2	1	1.9	9.5	46	-	
2020	-	0	0.1	0	0.8	0.1	0.2	0	0.2	0.3	1.7	27	70.6	29
2021	-	-	-	-	-	-	-	-	-	-	-	-	0	
2022	-	0	0	0.1	0.3	0	0.6	0.4	1.2	0.4	3	22	224.8	37
2023	0	0	0	0	0.6	0.1	0.3	0	1.2	1.9	4.2	27	107.1	29

**Table 15.** Golden redfish *Sebastes norvegicus* biomass indices (tons).

Year	0A	1AN	1AS	1AX	1BN	1BS	1C	1D	1E	1F	West	cv	East	cv
2006	91	311	696	724	986	197	1049	145	491	554	5242	16	-	
2007	358	249	596	136	1598	373	825	180	227	674	5216	27	2801	48
2008	339	186	157	211	1970	14	189	108	235	2030	5438	41	34098	32
2009	244	117	317	156	1434	642	383	70	315	426	4103	18	40496	27
2010	278	154	1207	954	1024	149	674	275	272	276	5264	28	28781	32
2011	-	608	257	1578	2828	338	1270	2483	165	777	10304	21	384970	36
2012	-	342	274	706	2049	327	1140	566	72	8925	14400	61	97601	28
2013	81	304	520	357	3064	228	1239	842	2439	2025	11096	31	318387	60
2014	-	299	108	142	3066	77	709	1152	1454	1169	8176	19	150846	43
2015	-	173	0	968	2214	246	546	2165	1785	2665	10762	22	226724	37
2016	-	495	228	420	434	376	612	2364	26182	1055	32166	106	322691	73
2017	0	0	134	125	1685	75	1077	912	618	1046	5672	13	-	
2018	-	24	67	129	2795	10	341	381	1260	1475	6482	23	-	
2019	-	633	190	384	3126	66	11845	288	781	1537	18850	61	-	
2020	-	0	124	67	1100	97	332	0	258	339	2316	29	40293	41
2021	-	-	-	-	-	-	-	-	-	-	-	-	-	
2022	-	0	71	200	414	83	950	370	2430	596	5114	28	83074	39
2023	-	42	73	122	505	35	196	13	3017	2697	6701	36	61994	31

**Table 16.** American plaice *Hippoglossoides platessoides* abundance indices (millions).

t	0A	1AN	1AS	1AX	1BN	1BS	1C	1D	1E	1F	West	CI	East	
1992		1.4	1.0	2.8	1.4	0.6	1.7	1.4	0.5	0.1	10.8	22		
1993		1.3	1.7	1.2	3.0	0.8	2.0	1.7	0.6	0.9	13.2	24		
1994		2.2	3.7	3.3	14.9	7.0	9.5	0.7	0.3	0.5	42.0	32		
1995		1.0	0.6	1.8	6.3	0.9	2.7	3.0	0.3	0.5	17.2	29		
1996		1.6	3.4	7.3	4.6	1.7	4.2	3.1	0.1	0.7	26.6	18		
1997		6.6	2.0	2.7	15.1	1.0	10.4	2.0	0.3	0.7	40.8	47		
1998		1.6	1.9	2.4	3.6	1.2	1.5	6.4	0.9	5.6	25.2	27		
1999		0.5	1.7	2.0	6.8	1.2	5.3	1.9	1.0	0.6	20.9	18		
2000		1.8	4.8	6.7	14.8	1.9	3.5	3.8	0.5	0.5	38.5	23		
2001		1.3	1.3	2.2	13.6	1.5	3.5	2.3	0.6	0.6	26.8	31		
2002		0.0	3.8	4.7	8.8	1.8	5.1	31.8	1.5	1.8	59.5	49		
2003		2.2	5.2	5.5	25.7	1.6	13.7	15.0	0.8	2.0	71.7	22		
2004		0.7	1.4	5.3	11.9	2.8	10.2	8.9	0.6	1.6	43.4	27		
		New survey gear introduced										cv	cv	
2005	3.5	2.1	13.7	5.8	59.9	17.3	74.5	19.5	6.1	5.6	208.0	9		
2006	3.9	1.3	15.0	10.9	40.3	10.0	38.1	21.6	4.4	4.5	150.0	10		
2007	6.5	0.6	12.3	6.3	46.8	9.4	31.2	11.9	2.6	2.7	130.8	12		
2008	7.1	3.7	10.8	4.0	29.5	2.2	13.5	11.4	1.3	1.3	84.8	8	17.2	22
2009	2.9	5.6	18.0	14.3	41.4	8.1	11.6	7.6	1.1	2.3	112.8	9	20.2	12
2010	9.5	2.8	40.7	14.3	50.7	9.2	34.4	20.3	1.2	2.1	185.2	8	17.4	19
2011	-	8.6	40.7	17.1	103.6	6.2	30.3	21.6	0.8	1.9	230.7	11	17.5	16
2012	-	2.3	18.3	15.3	51.3	8.3	19.4	11.4	0.9	1.1	129.4	9	10.4	22
2013	4.4	19.0	39.0	25.4	84.1	9.1	34.1	27.9	4.7	0.9	248.6	13	13.1	17
2014	-	7.0	22.0	11.0	36.0	6.0	15.0	10.0	2.0	1.0	110.0	7	10.0	19
2015	-	41.0	55.0	28.0	89.0	39.0	25.0	17.0	2.0	1.0	296.0	10	10.8	23
2016	-	10.1	21.6	11.3	43.1	2.4	16.2	7.6	2.2	1.2	115.7	8	10.1	14
2017	5	6.3	23.3	26.9	64.1	18.8	23.4	11.2	1.4	1.1	181.5	9	-	-
2018	0	11,9	20,4	21,8	126	11,4	20,7	8,7	2,4	2,1	225,4	10	-	-
2019		13,2	22,5	38,2	40,7	1,2	20,4	10	1,9	3,3	151,3	8	-	-
2020		7.4	13.3	12.4	38	29.7	13.8	12.6	2	1.9	131.2	9	24,3	14
2021														
2022		4,8	27,7	18,8	65,8	13	28,4	9,5	2	1,5	171,6	8	30,6	22
2023		4.1	29	13.9	97.6	8.6	16.8	6.1	2.2	1.8	180.1	20	19.6	11

**Table 17.** American plaice *Hippoglossoides platessoides* biomass indices (tons).

Year	0A	1AN	1AS	1AX	1BN	1BS	1C	1D	1E	1F	West	CI	East	
1992		57	54	213	78	51	137	128	55	6	779	23		
1993		56	72	87	90	28	107	141	69	43	694	26		
1994		112	293	277	487	308	284	60	22	64	1906	22		
1995		65	54	279	191	51	87	130	19	18	895	18		
1996		119	264	670	231	74	142	119	7	27	1654	18		
1997		323	150	287	398	87	367	135	31	25	1803	21		
1998		154	178	328	185	48	82	398	97	102	1573	20		
1999		81	136	170	287	43	202	145	65	44	1173	17		
2000		175	278	408	551	74	178	227	89	40	2021	18		
2001		169	79	140	403	65	162	153	38	67	1276	17		
2002		0	184	327	414	151	275	1061	92	67	2570	23		
2003		196	352	338	1013	125	680	1048	59	171	3980	20		
2004		138	143	192	537	128	715	747	38	150	2789	27		
		New survey gear introduced										cv	cv	
2005	246	346	944	722	3049	1136	4511	2196	470	569	14190	8		
2006	268	210	608	1148	2288	702	3534	2163	399	380	11699	13		
2007	356	112	544	731	2877	731	2418	810	230	308	9118	12		
2008	371	437	648	382	1889	212	1067	898	128	149	6181	9	2495 42	
2009	183	556	649	643	1977	585	826	825	102	127	6473	7	2577 15	
2010	355	235	1539	1214	2436	748	2128	1460	105	224	10442	9	3181 30	
2011	-	463	1364	1459	5464	792	1391	2020	99	208	13256	7	4385 26	
2012	-	236	756	730	3508	662	1350	777	121	178	8317	9	2702 33	
2013	325	920	1472	1457	4066	521	2818	1425	568	121	13694	10	2269 31	
2014	-	311	746	990	2245	337	1089	1027	203	130	7078	7	1203 26	
2015	-	2046	1320	2956	4547	1364	1635	1642	246	188	15944	9	2351 30	
2016	-	563	1428	1117	2735	201	1152	841	324	146	8508	7	2385 18	
2017	303	734	965	1726	2759	1122	1632	1218	195	148	10802	8	- -	
2018		1699	997	1988	5928	719	1164	1055	282	178	14009	10	- -	
2019		1825	1564	3039	2121	212	1592	1132	235	299	12019	7	- -	
2020		1175	1702	1363	2341	1417	1376	1759	282	215	11630	8	3693 21	
2021														
2022		894	1583	1775	3877	666	2301	1313	339	236	12984	7	4728 36	
2023		603	976	1148	3724	637	1620	786	365	319	10178	12	2830 18	

**Table 18.** Atlantic wolffish *Anarhichas lupus* abundance indices (millions).

Year	0A	1AN	1AS	1AX	1BN	1BS	1C	1D	1E	1F	West	CI	East
1992		0.0	0.0	0.0	0.0	0.1	0.3	0.1	0.1	0.1	0.8	33	
1993		0.0	0.0	0.0	0.0	0.0	0.2	0.2	0.3	0.3	1.2	41	
1994		0.0	0.1	0.0	0.3	0.2	1.9	0.4	0.4	1.6	4.9	36	
1995		0.0	0.0	0.0	0.1	0.1	0.4	0.1	0.4	0.2	1.3	34	
1996		0.0	0.1	0.0	0.1	0.1	0.4	0.2	0.6	0.6	2.0	50	
1997		0.0	0.0	0.0	0.2	0.0	0.8	0.2	0.3	0.1	1.7	28	
1998		0.0	0.3	0.0	0.3	0.1	0.7	0.4	0.5	0.7	3.0	30	
1999		0.0	0.2	0.1	0.1	0.1	0.4	0.2	0.4	0.4	2.0	44	
2000		0.0	0.5	0.1	0.3	0.4	0.4	0.6	1.7	0.0	4.0	69	
2001		0.0	0.1	0.2	0.4	0.1	0.2	0.4	0.2	0.1	1.5	40	
2002		0.0	0.4	0.1	0.5	0.0	0.9	0.6	1.1	0.5	4.1	33	
2003		0.0	0.1	0.6	2.3	0.2	1.5	0.5	2.3	1.1	8.8	27	
2004		0.0	0.1	0.3	1.6	0.9	0.2	0.3	0.7	0.3	4.4	39	
		New survey gear introduced										cv	cv
2005	0.1	0.0	0.5	0.0	1.5	0.6	6.9	2.4	5.5	1.5	19.1	16	
2006	0.0	0.1	0.8	0.1	0.9	0.6	2.4	1.2	1.0	2.8	9.8	14	
2007	0.0	0.0	0.7	0.0	1.3	0.6	0.7	0.3	0.4	0.7	4.8	15	-
2008	0.2	0.0	1.0	0.1	0.7	0.5	1.0	0.5	0.4	0.3	4.6	15	4.7
2009	0.0	0.1	1.0	0.1	0.7	0.4	1.5	0.2	1.1	0.4	5.6	19	12.2
2010	0.1	0.4	2.6	0.1	2.3	0.6	3.1	0.8	0.9	0.6	11.4	8	5.3
2011	-	0.1	1.1	0.1	1.3	0.3	0.5	0.9	0.3	0.4	5.0	14	6.4
2012	-	0.0	2.2	0.2	1.6	0.3	0.7	1.2	0.3	0.6	7.0	18	3.8
2013	0.1	0.1	3.1	0.0	1.0	0.3	1.7	0.4	0.5	0.8	7.9	18	6.5
2014	-	0.4	2.3	0.3	0.7	0.8	0.3	0.1	0.2	0.3	5.5	16	2.6
2015	-	0.6	4.3	0.3	3.1	4.6	6.3	1.1	0.8	0.3	21.5	23	2.9
2016	-	0.5	1.8	0.2	1.2	1	1.4	0.2	0.4	1	7.7	10	2.3
2017	0.1	0.5	5.8	0.4	2.3	2.9	3.6	0.4	0.2	0.4	16.7	20	-
2018	0	1.2	4.4	0	4.9	2.1	3	0.7	0.3	0.6	17.2	15	-
2019	0	1	3.6	0.5	1.7	0.7	2.1	1.2	1	1.5	13.4	12	-
2020		1.1	2.9	0.1	1.7	3.1	1.8	0.2	1.2	1.7	13.8	17	17.3
2021													0
2022		0.5	3.5	0.1	2.1	3.1	4.5	1.0	0.5	1.7	17.0	11	22.7
2023	0	0.2	2.7	0.0	6.3	2.7	2.9	0.4	1.2	0.8	17.1	19	12.3



**Table 19.** Atlantic wolffish *Anarhichas lupus* biomass indices (tons).

Year	0A	1AN	1AS	1AX	1BN	1BS	1C	1D	1E	1F	West	CI	East	
1992		0	7	0	8	21	47	22	28	31	163	33		
1993		0	5	6	1	2	26	35	29	188	292	64		
1994		0	12	9	40	39	198	30	65	249	644	38		
1995		0	0	0	22	9	38	24	90	36	219	40		
1996		0	1	3	17	23	41	35	103	101	324	53		
1997		0	3	0	21	1	115	16	58	15	228	30		
1998		0	3	2	13	9	60	34	104	133	358	38		
1999		0	4	13	21	12	8	6	202	62	329	79		
2000		0	20	3	52	31	55	54	396	15	626	90		
2001		0	1	3	11	1	16	21	42	23	117	40		
2002		0	9	2	77	5	73	78	216	118	579	37		
2003		0	2	41	267	64	361	60	205	148	1148	24		
2004		0	6	19	160	56	96	21	162	100	620	27		
		New survey gear introduced											cv	cv
2005	11	0	76	5	201	123	1564	348	890	640	3858	16		
2006	3	4	58	60	127	134	359	168	172	1241	2326	20		
2007	0	0	73	6	357	326	147	107	122	533	1670	21	-	
2008	15	0	76	31	124	55	348	88	136	226	1098	16	1091	26
2009	0	3	109	30	155	72	275	92	211	648	1595	31	2870	32
2010	10	12	509	51	350	144	668	134	104	345	2327	17	1295	25
2011	-	46	96	64	197	69	121	233	63	205	1094	17	1633	40
2012	-	0	239	82	506	44	79	252	64	444	1708	23	1172	20
2013	9	27	239	20	136	81	555	183	115	636	2000	25	1652	24
2014	-	9	79	69	158	62	107	78	100	458	1121	30	520	34
2015	-	56	450	168	478	762	1543	752	547	310	5066	22	1585	32
2016	-	60	270	174	271	228	440	156	119	708	2425	14	952	30
2017	2	58	437	215	381	454	960	321	168	586	3583	15	-	-
2018		109	291	13	730	294	491	451	88	691	3158	15	-	-
2019	0	124	359	94	393	54	770	297	832	507	3431	19	-	-
2020		90	520	36	251	545	497	32	321	927	3218	15	1938	18
2021													0	
2022		85	430	23	462	870	1000	473	461	1107	4912	12	2527	28
2023	0	37	574	31	825	894	923	292	252	633	4462	12	2126	23

**Table 20.** Spotted wolffish *Anarhichas minor* abundance indices (millions).

Year	0A	1AN	1AS	1AX	1BN	1BS	1C	1D	1E	1F	West	CI	East
1992		0.0	0.1	0.0	0.1	0.0	0.0	0.0	0.0	0.0	0.3	28	
1993		0.0	0.1	0.0	0.1	0.0	0.1	0.0	0.0	0.1	0.4	36	
1994		0.0	0.3	0.0	0.2	0.1	0.4	0.0	0.0	0.0	1.1	33	
1995		0.0	0.2	0.0	0.1	0.0	0.0	0.0	0.0	0.0	0.4	22	
1996		0.1	0.1	0.0	0.1	0.0	0.0	0.0	0.0	0.0	0.5	24	
1997		0.1	0.3	0.0	0.2	0.0	0.0	0.1	0.0	0.0	0.8	23	
1998		0.1	0.2	0.0	0.2	0.0	0.0	0.0	0.0	0.0	0.6	25	
1999		0.9	0.3	0.1	0.4	0.1	0.0	0.0	0.0	0.0	1.7	42	
2000		0.0	0.8	0.0	0.5	0.1	0.0	0.0	0.1	0.0	1.6	28	
2001		0.3	0.4	0.1	0.3	0.0	0.0	0.0	0.0	0.0	1.1	27	
2002		0.3	2.1	0.1	0.4	0.1	0.1	0.1	0.0	0.0	3.1	42	
2003		0.5	1.5	0.2	1.4	0.0	0.6	0.0	0.0	0.1	4.3	24	
2004		0.2	0.7	0.2	0.6	0.0	0.1	0.1	0.0	0.1	2.1	30	
		New survey gear introduced										cv	cv
2005	0.0	1.2	1.9	0.0	0.7	0.2	0.4	0.3	0.2	0.1	5.1	23	
2006	0.0	0.4	1.0	0.1	1.4	0.3	0.3	0.2	0.1	0.2	3.9	23	
2007	0.1	0.5	1.0	0.1	1.5	0.4	0.2	0.1	0.0	0.1	3.9	31	-
2008	0.1	0.5	0.6	0.1	0.4	0.0	0.1	0.1	0.0	0.1	2.1	15	1.1
2009	0.0	0.4	1.7	0.1	0.6	0.1	0.0	0.0	0.0	0.1	3.1	26	2.3
2010	0.2	1.0	1.8	0.2	0.7	0.2	0.2	0.1	0.1	0.2	4.5	12	2.9
2011	-	0.9	1.8	0.2	0.9	0.1	0.2	0.1	0.0	0.1	4.4	14	2.3
2012	-	0.8	1.0	0.1	0.7	0.1	0.1	0.2	0.1	0.2	3.2	15	2.9
2013	0.1	1.3	2.2	0.2	1.7	0.1	0.3	0.2	0.4	0.4	6.9	20	2.5
2014	-	1.4	2.3	0.1	0.2	0	0.1	0.2	0.2	0.2	4.7	21	1.5
2015	-	2.2	2.2	0.2	0.7	0.4	0.5	0.4	0.2	0.4	7.4	14	2.0
2016	-	1.7	1.2	0.1	0.5	0.1	0.6	0.2	0.3	0.2	4.9	17	1.3
2017	0	2.7	2.1	0.3	0.7	0.5	0.3	0.1	0.3	0.4	7.5	16	-
2018	-	1.7	2,5	0,3	1,6	0,3	0,3	0,2	0,3	0,1	7,5	11	-
2019	0	0,8	2,4	0,3	1,2	0	0,3	0,3	0,2	0,9	6,5	13	-
2020		1.1	2.3	0.2	1.1	0.6	0.3	0	0.5	0.6	6.7	12	2,4
2021													
2022		0,7	2,1	0,3	0,7	0,2	0,4	0,4	0,4	0,6	5,8	12	1,6
2023	0	0.6	0.6	0.2	0.7	0.2	0.3	0.3	0.6	0.4	3.8	19	1.9

**Table 21.** Spotted wolffish *Anarhichas minor* biomass indices (tons).

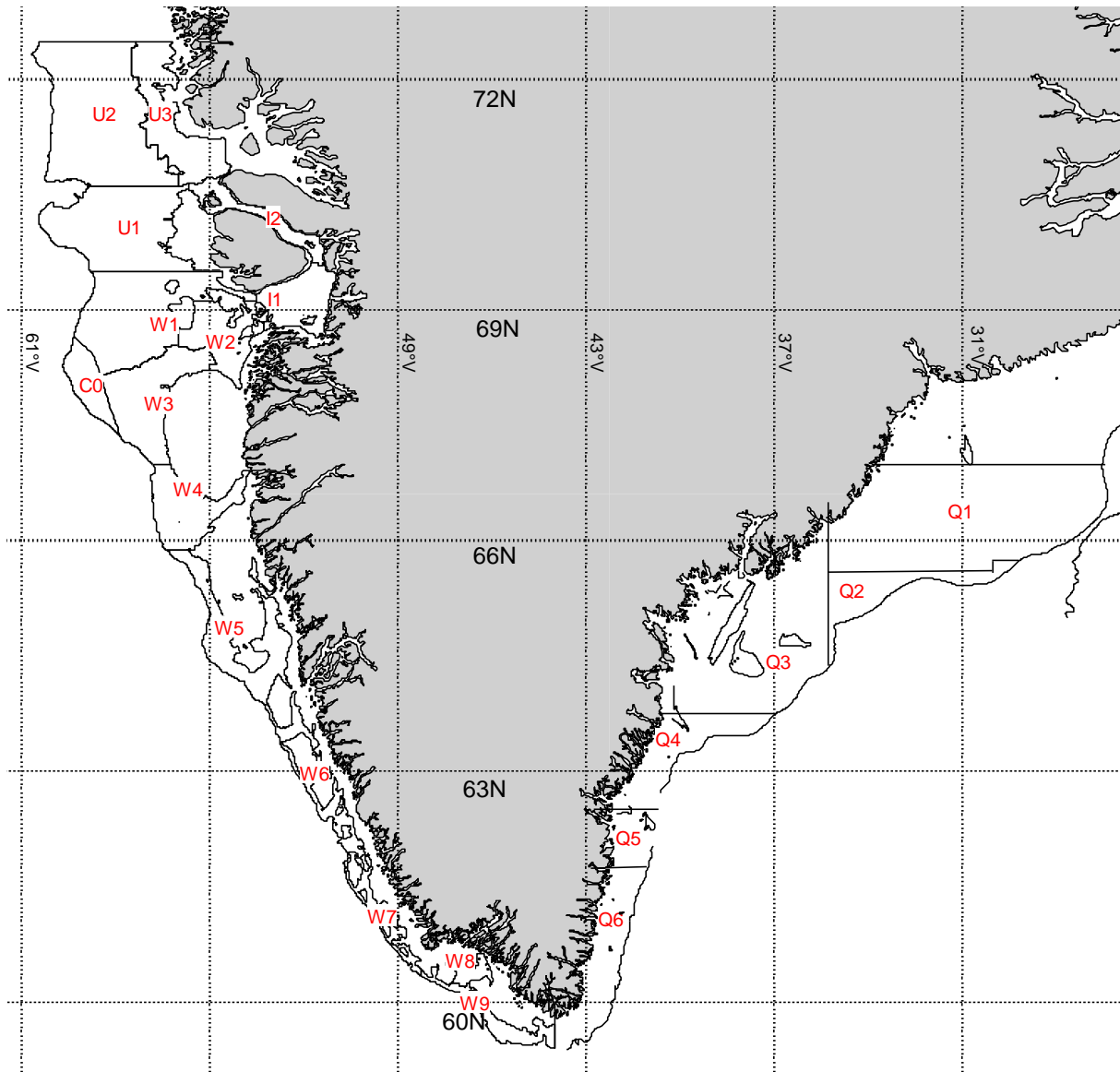
Year	0A	1AN	1AS	1AX	1BN	1BS	1C	1D	1E	1F	West	CI	East	
1992		4	76	65	110	3	34	33	6	19	351	28		
1993		55	0	100	47	16	66	4	0	282	571	53		
1994		223	180	0	81	40	119	28	11	1	683	25		
1995		0	60	15	68	16	22	19	11	164	377	49		
1996		169	77	12	193	15	6	31	0	50	554	26		
1997		193	72	37	81	0	16	124	0	5	530	34		
1998		2	64	0	143	18	6	125	100	7	465	32		
1999		131	121	23	28	36	13	2	0	0	354	31		
2000		0	188	31	133	36	19	1	593	0	1000	114		
2001		523	30	25	310	80	4	0	0	10	982	52		
2002		135	194	20	169	81	74	233	71	126	1104	28		
2003		299	1416	195	978	22	741	107	0	226	3985	22		
2004		124	1270	623	567	2	78	603	352	545	4164	35		
		New survey gear introduced											cv	cv
2005	150	764	1182	6	1058	155	741	2514	568	137	7275	26		
2006	0	472	1257	243	1345	1066	1336	716	350	1145	7930	19		
2007	14	543	705	196	1249	678	874	372	178	634	5442	17	-	-
2008	63	1487	2050	74	730	24	347	995	425	372	6567	44	5262	49
2009	0	280	627	653	1453	154	35	129	189	160	3662	18	2890	27
2010	66	2363	1508	1195	1006	167	222	238	212	1715	8691	18	3877	36
2011	-	2537	2244	742	2460	1210	2294	479	218	769	12955	23	6133	28
2012	-	1227	683	464	3166	325	468	390	555	1104	8383	21	6871	30
2013	7	2026	2402	544	3135	632	1494	658	3163	4845	18906	22	4622	31
2014	-	779	3038	381	753	9	427	2740	1496	1916	11538	23	10468	25
2015	-	3994	3814	843	3655	518	1451	3208	1127	3646	22256	15	3227	29
2016	-	700	1755	279	1333	382	2726	1164	2999	1099	12436	22	4623	34
2017	0	4184	5387	804	858	937	212	604	3269	3701	19957	21	-	-
2018	-	4009	1811	508	2795	801	1040	1358	2406	1083	15812	19	-	-
2019	-	1518	3012	974	4346	12	736	1386	1279	8988	22252	32	-	-
2020		2750	3366	1352	2080	5470	1288	89	4525	6691	27611	22	3900	35
2021														
2022		1091	2631	1028	1998	1073	2581	3441	3778	5834	23454	17	2947	32
2023	0	578	1006	1053	957	757	1464	2522	6218	4713	19268	15	3123	32

**Table 22.** Thorny skate (*Amblyraja radiata*) abundance indices (millions).

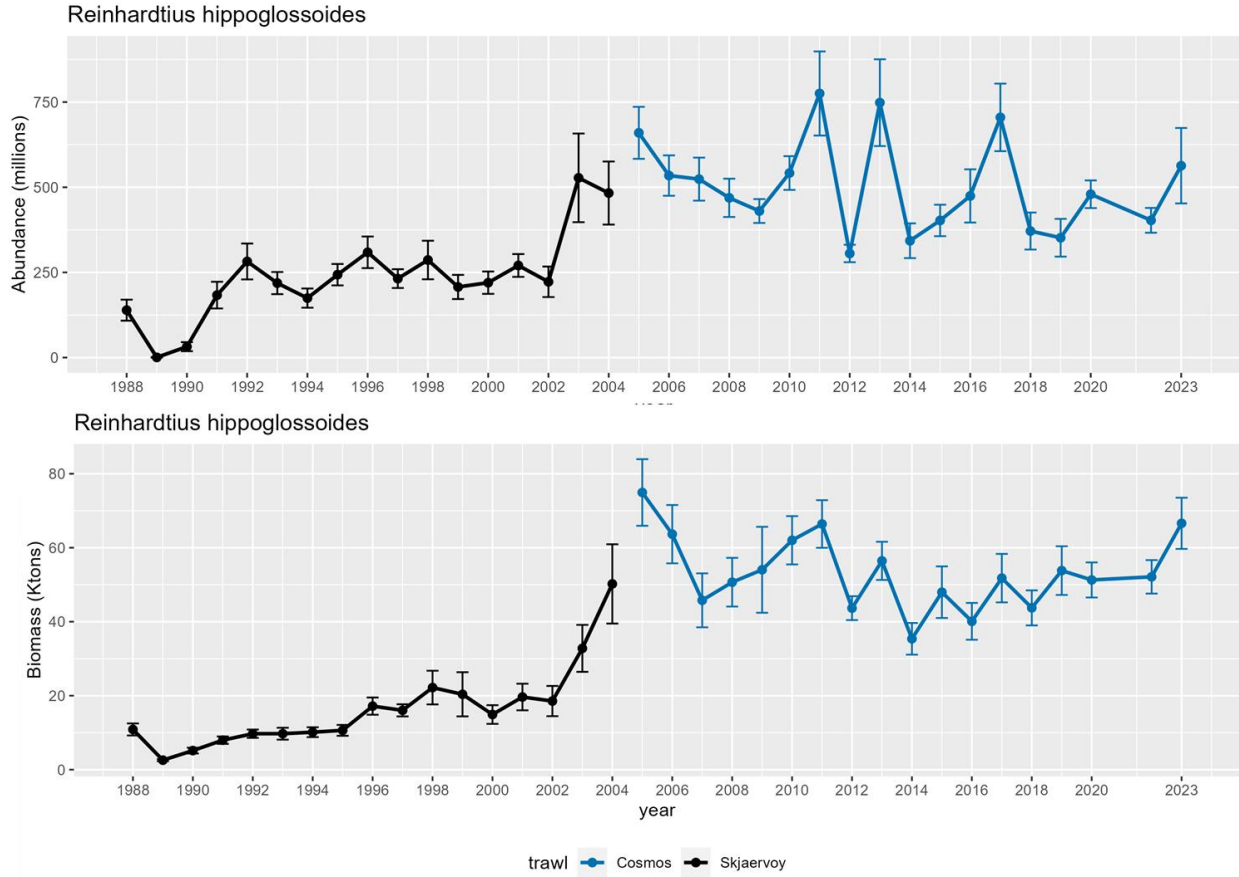
	1AN	1AS	1AX	1BN	1BS	1C	1D	1E	1F	West	CI	East		
1992	2.9	1.3	1.3	1.4	0.2	0.6	1.0	0.1	0.0	9.0	25			
1993	0.7	0.4	0.8	1.6	0.5	0.9	0.5	0.6	0.2	6.1	21			
1994	1.9	1.8	1.2	3.9	1.8	2.8	0.4	0.2	0.0	14.1	21			
1995	2.7	1.3	0.8	2.8	1.8	0.7	2.4	0.5	0.1	13.1	26			
1996	4.6	2.2	1.5	4.0	0.4	0.7	0.6	0.0	0.6	14.6	23			
1997	4.6	1.4	0.6	4.4	0.2	2.3	0.7	0.1	0.0	14.4	26			
1998	2.8	4.1	3.2	3.0	0.3	0.6	0.9	0.4	0.3	15.5	25			
1999	1.7	3.2	0.9	2.8	0.3	1.0	0.8	0.2	0.2	11.0	23			
2000	2.1	3.4	2.0	4.0	0.5	0.6	0.5	0.1	0.6	13.9	23			
2001	3.2	1.2	0.6	2.3	0.3	0.4	0.5	0.1	0.2	8.8	32			
2002	0.5	1.1	0.9	2.2	0.4	0.9	2.6	0.2	0.5	9.3	25			
2003	3.9	2.4	1.4	7.2	0.1	0.7	0.8	0.2	0.7	17.4	26			
2004	2.5	1.3	1.3	1.2	0.2	0.2	0.7	0.2	0.1	7.9	24			
	New survey gear introduced											cv	cv	
2005	0.1	4.1	2.8	2.2	3.7	0.5	0.8	0.6	0.4	0.2	15.4	10		
2006	0.2	3.8	2.2	3.0	2.8	0.2	2.3	2.8	0.5	1.1	18.8	10		
2007	0.1	3.3	1.4	1.6	3.8	0.1	1.3	0.9	1.4	0.4	14.3	20	-	
2008	0.2	5.4	1.4	1.0	1.9	0.1	0.5	1.1	0.1	0.2	11.9	16	0.7	49
2009	0.0	10.9	1.1	3.9	1.9	0.3	0.3	0.6	0.2	0.4	19.7	20	2.3	15
2010	0.1	5.6	4.0	4.1	3.3	0.8	2.7	1.2	0.1	0.0	21.8	12	2.9	23
2011	-	5.5	2.3	3.6	6.7	0.4	4.0	4.9	1.7	0.1	29.2	16	2.2	21
2012	-	2.7	2.2	2.4	4.7	0.5	1.3	2.1	0.1	0.0	16.1	15	1.8	26
2013	0.4	4.9	2.1	3.2	9.1	0.6	1.7	1.1	0.1	0.1	23.4	27	1.6	23
2014	-	2.4	2.4	1.6	1.9	0.5	0.7	0.2	0.1	0	9.8	13	0.6	39
2015	-	7.8	8.7	6.5	7.6	5.7	2.5	3.2	0.2	0.2	42.3	15	1.3	28
2016	-	3.3	2.1	3	3.6	0.6	0.9	0.8	0.1	0.1	14.3	11	1.2	20
2017	0	2.3	3.5	4.7	2.3	4.1	2	0.5	0	0	19.4	10	-	-
2018		6,1	4,6	4,9	5,2	1,7	1,4	1	0,1	0	25,1	9		
2019		5,4	4,6	5,2	5,3	0,4	3,5	1	0	0,1	25,7	12		
2020		4,9	4,7	3	4,9	4,6	1,7	1	0,4	0,1	25,2	13	1,4	22
2021														
2022		9,7	4,5	5,3	6,5	3,9	4	0,9	0	0	34,7	12	1,1	22
2023	0	7.1	2.1	2	8	1.6	1	0.5	0	0	22.2	14	0.8	24

**Table 23.** Thorny skate *Amblyraja radiata* biomass indices (tons).

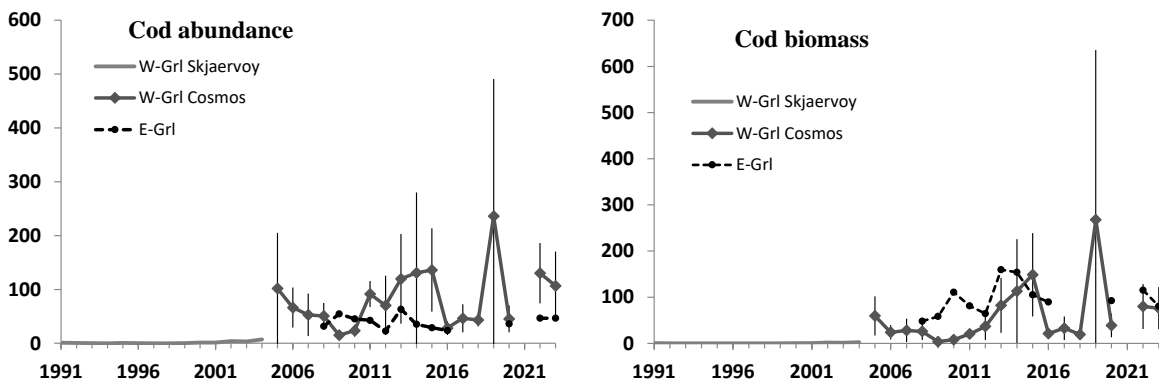
Year	1AN	1AS	1AX	1BN	1BS	1C	1D	1E	1F	West	CI	East	
1992	370	268	162	226	37	57	113	32	5	1271	20		
1993	60	65	199	171	87	116	128	40	22	887	24		
1994	494	283	182	465	275	311	55	61	3	2129	23		
1995	253	227	301	451	327	121	300	78	24	2083	21		
1996	631	554	623	509	61	105	65	0	207	2755	23		
1997	830	411	322	566	56	156	187	25	7	2559	26		
1998	392	839	535	427	78	38	114	81	76	2580	26		
1999	278	931	253	247	45	94	96	25	49	2019	34		
2000	323	1178	345	428	122	84	120	3	197	2799	23		
2001	325	215	222	248	52	52	89	10	60	1272	28		
2002	13	246	320	280	101	86	687	63	177	1973	29		
2003	1005	902	567	1481	11	107	174	24	206	4478	25		
2004	598	520	791	197	47	33	333	98	78	2694	23		
	New survey gear introduced											cv	cv
2005	26	776	953	676	558	219	145	249	125	96	3822	15	
2006	66	836	364	662	361	91	477	807	224	303	4193	14	
2007	55	897	319	566	709	50	258	152	164	87	3258	15	-
2008	98	1411	315	400	353	20	45	222	25	47	2937	21	646
2009	7	2267	411	904	374	90	81	97	78	55	4365	11	1615
2010	20	1092	1036	1062	623	293	434	368	16	19	4962	11	2397
2011	-	970	556	1129	1152	84	477	1172	80	42	5661	11	1925
2012	-	738	635	722	910	107	192	145	31	16	3496	12	1546
2013	117	1222	756	1671	1453	219	408	255	57	40	6198	18	1613
2014	-	742	896	713	410	249	200	73	24	3	3311	17	497
2015	-	1467	1473	1830	1814	1582	273	791	90	145	9465	13	1362
2016	-	987	638	1011	937	290	406	395	53	67	4784	13	1052
2017	0	528	1072	1614	417	876	319	235	0	14	5076	10	-
2018		2032	1277	1888	1332	486	381	485	18	18	7916	10	
2019		1617	1513	2373	1137	319	885	354	3	69	8270	11	
2020		853	1572	1082	1409	876	273	259	35	39	6398	13	1207
2021													30
2022		1313	1120	2224	2064	1406	814	271	24	32	9267	12	1025
2023		1618	485	991	2126	421	267	199	4	9	6120	21	815



**Figure 1.** The Stratification areas used in the Greenland Shrimp and Fish survey. In West Greenland each strata is divided in depth strata of 150-200m, 200-300m, 300-400m and 400-600m. “Shallow” water strata of 0-100m and 100-150m delimited by the 3 nm line and the NAFO Div. Borders of the shallow water stratas are not shown. In East Greenland each strata is divided in depth strata of 200-400m and 400-600m. “Shallow” water strata of 0-200m is delimited by the 3 nm line.



**Figure 2.** Greenland halibut abundance (million) and biomass (Kt) for West Greenland



**Figure 3.** Atlantic cod abundance (million) and biomass (Kt) for West Greenland.

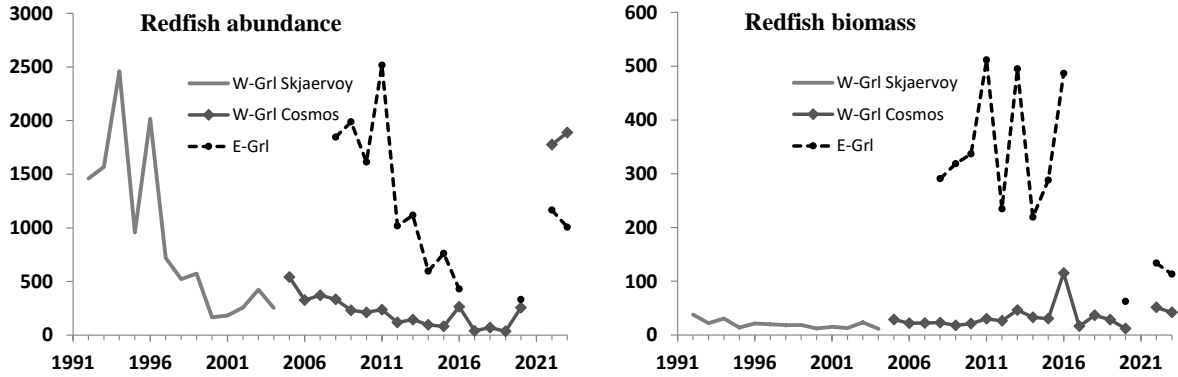


Figure 4a. Redfish species (*S. mentella* and *S. norvegicus* combined) abundance (million) and biomass (Kt) for West Greenland.

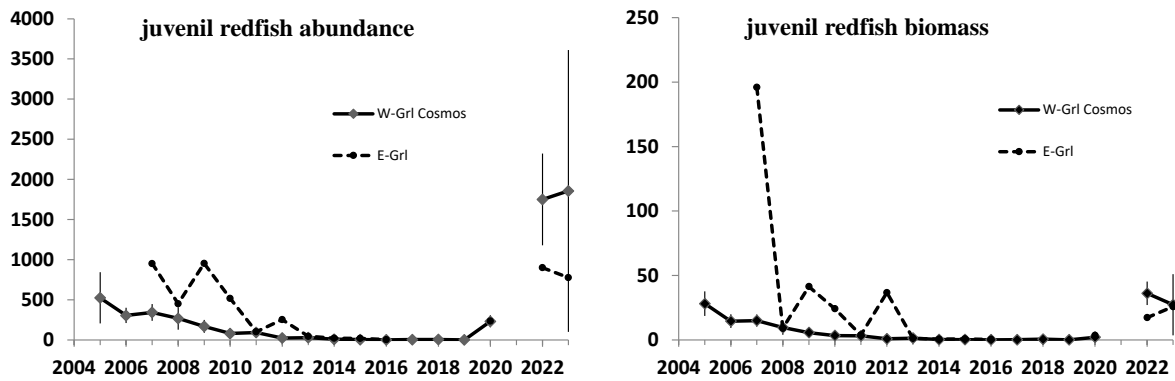


Figure 4b. Juvenil redfish <20 cm (*S. mentella* and *S. norvegicus* combined) abundance (million) and biomass (Kt).

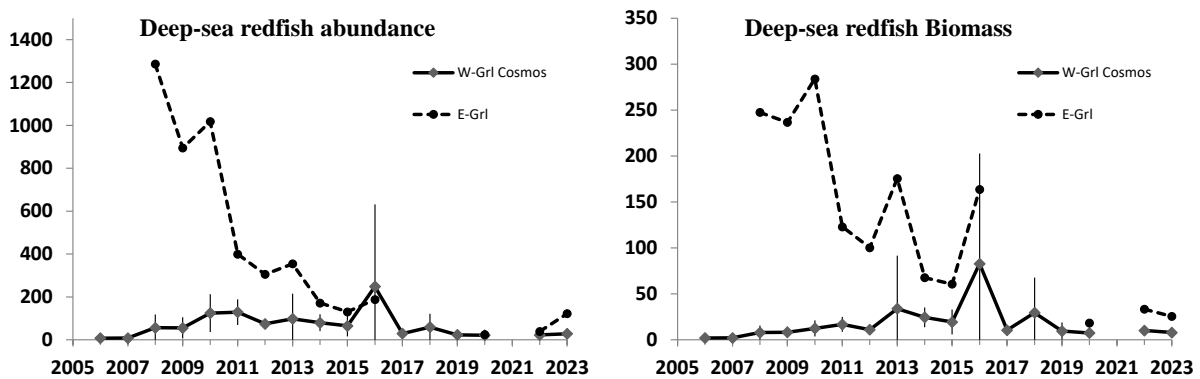


Figure 4c. Deep-sea redfish *S. mentella* abundance (million) and biomass (Kt).



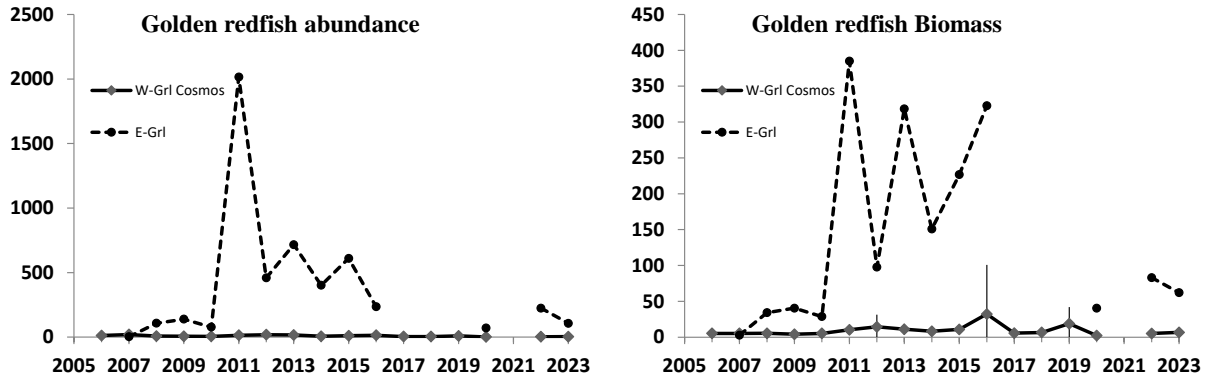


Figure 4d. Golden redfish *S. norvegicus* abundance (million) and biomass (Kt).

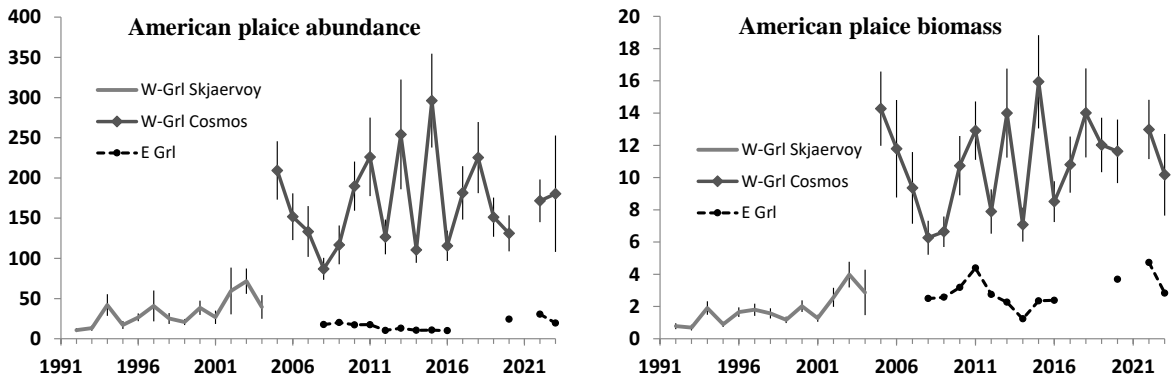


Figure 5. American plaice abundance (million) and biomass (Kt) for West Greenland.

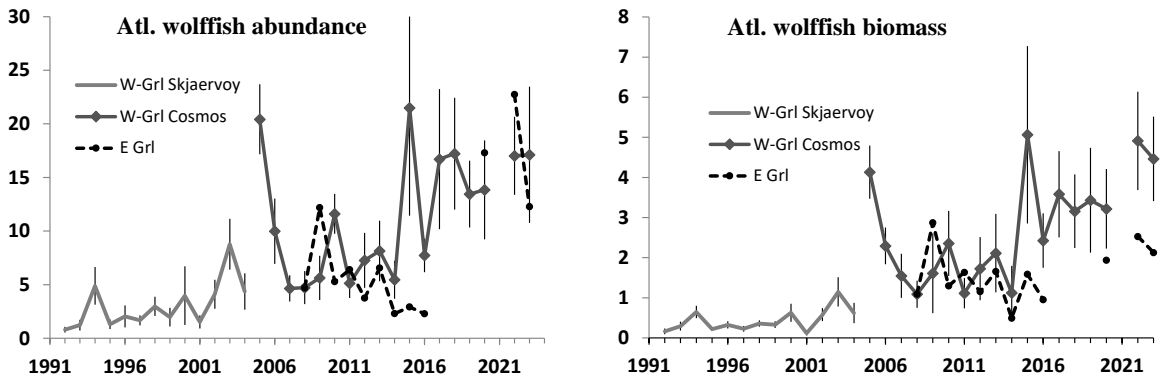


Figure 6. Atlantic wolffish abundance (million) and biomass (Kt) for West Greenland.

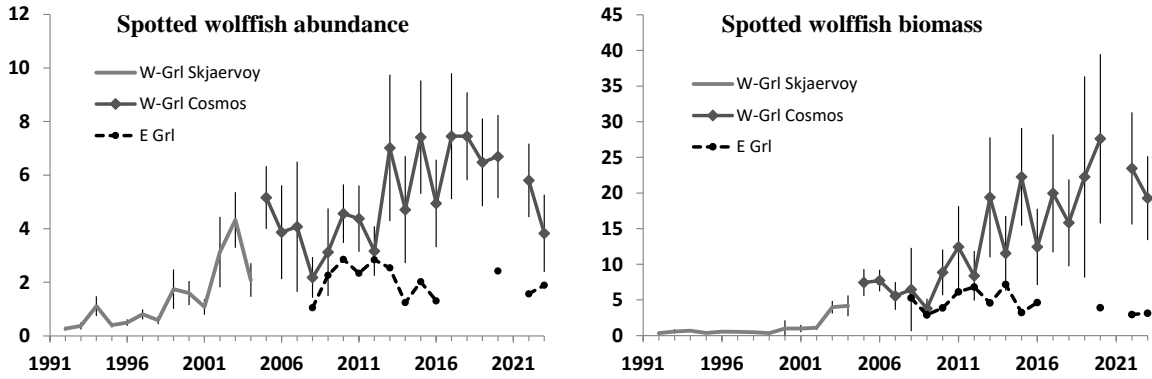


Figure 7. Spotted wolffish abundance (million) and biomass (Kt) for West Greenland.

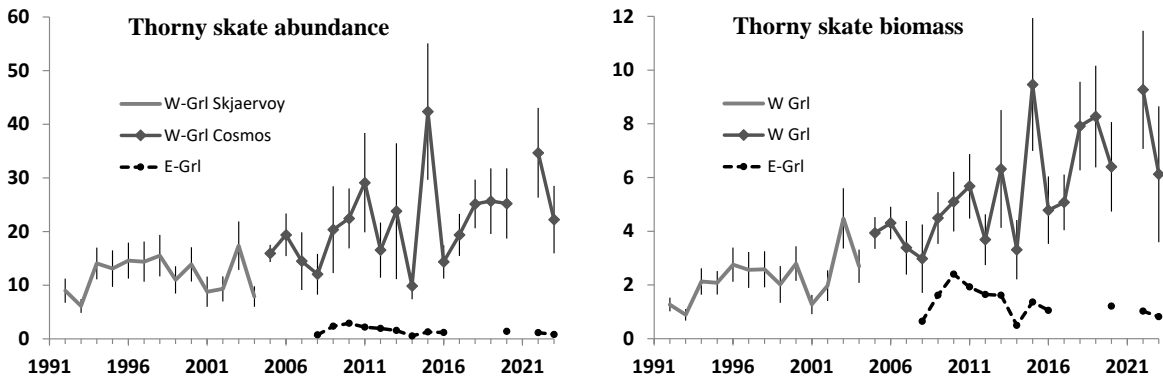


Figure 8. Thorny skate abundance (million) and biomass (Kt) for West Greenland.

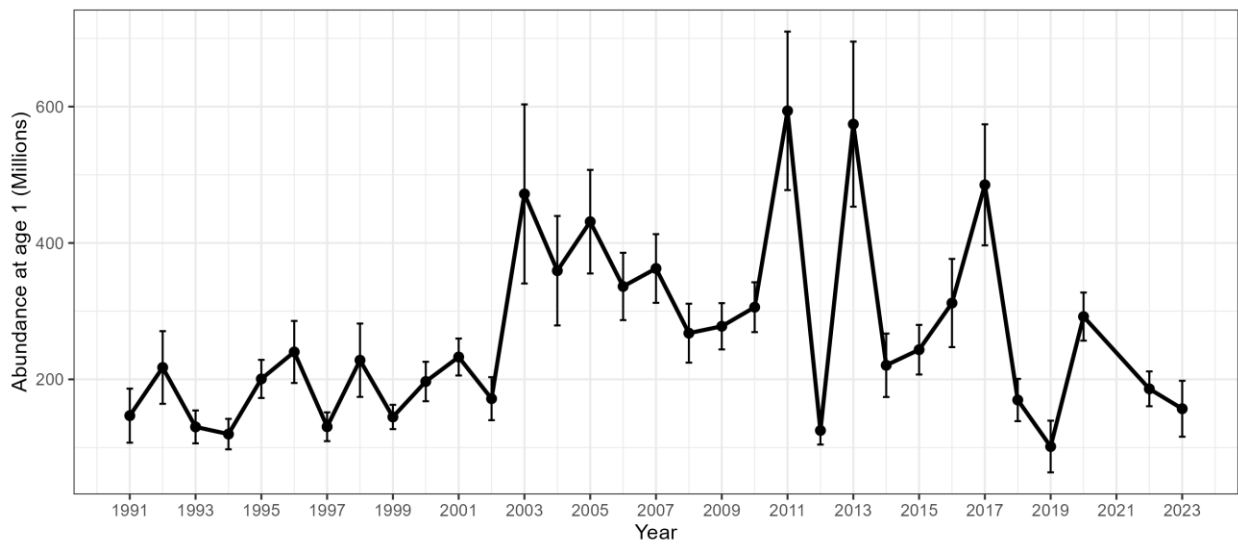
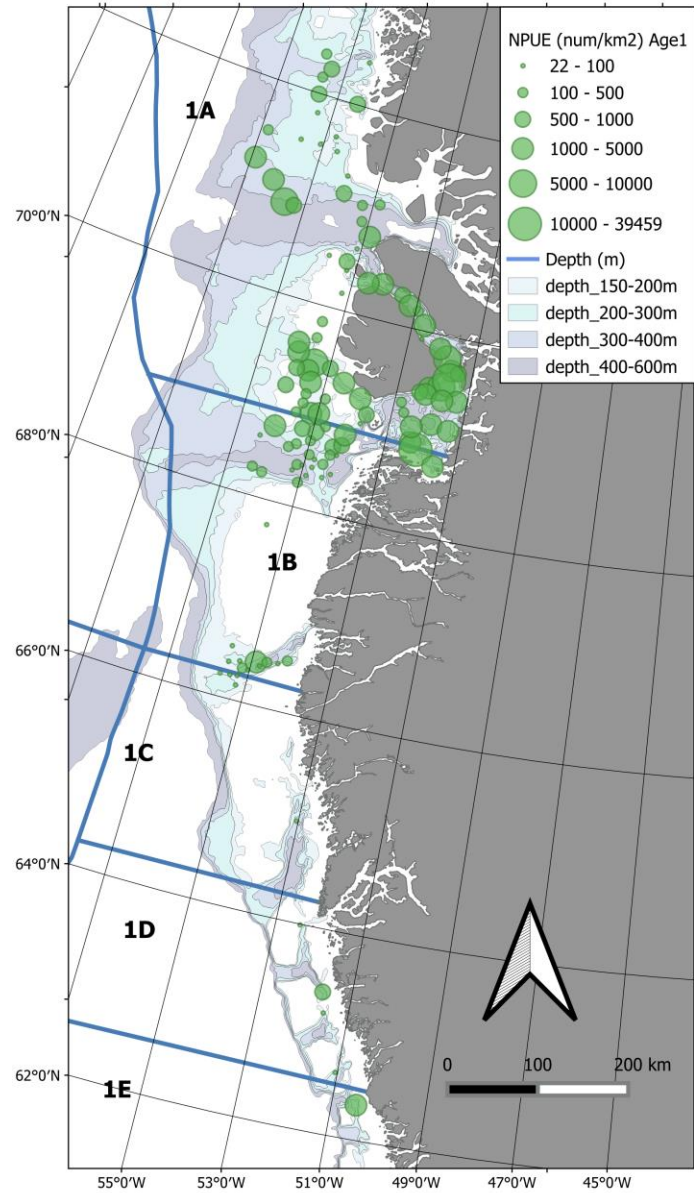


Figure 9. Total recruitment ('00000s ind.) of age 1 offshore SA1 and inshore 1A (Disko Bay).



**Figure 10.** Distribution in NPUE (num./km<sup>2</sup>) of one year old Greenland halibut in 2023.

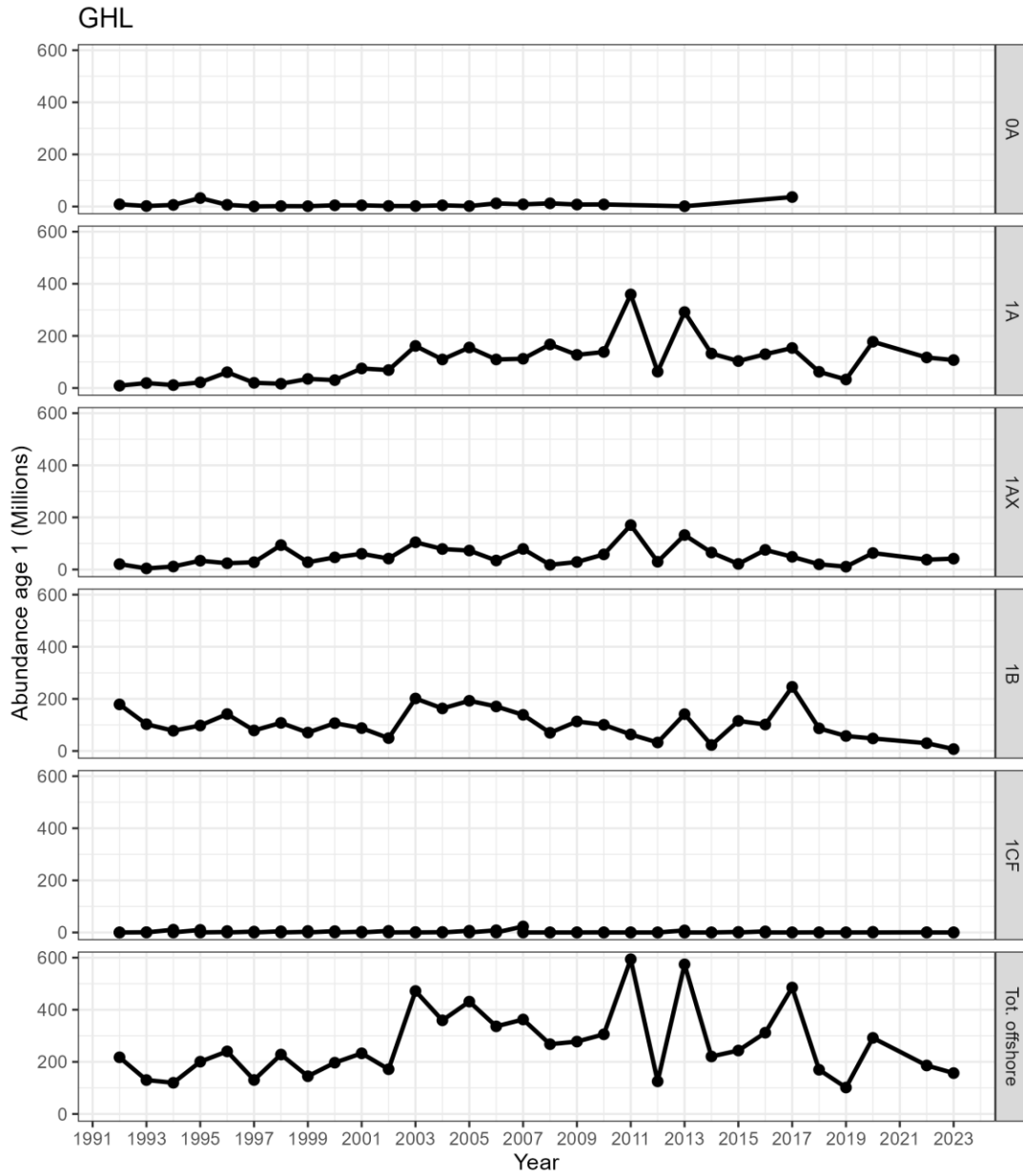
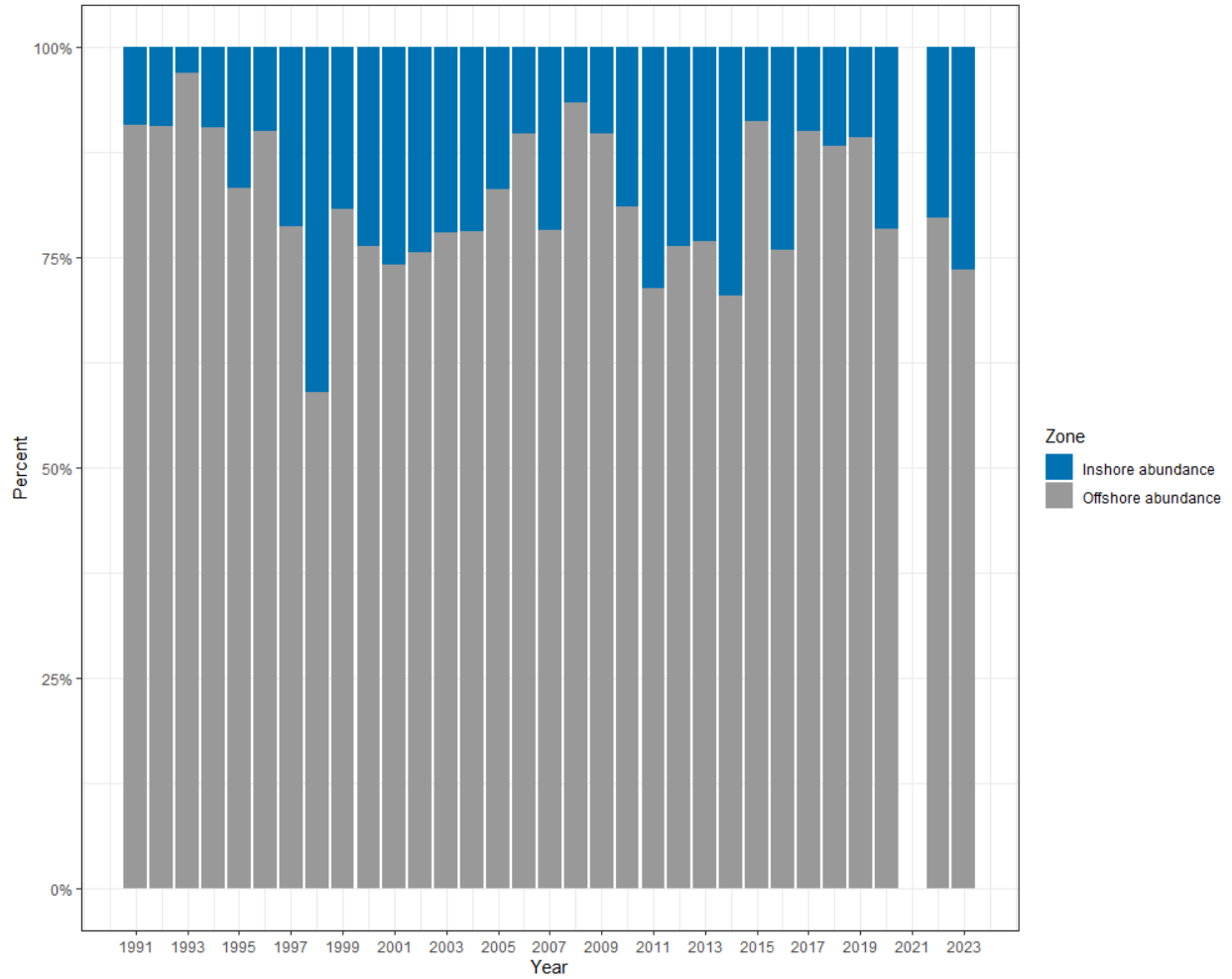
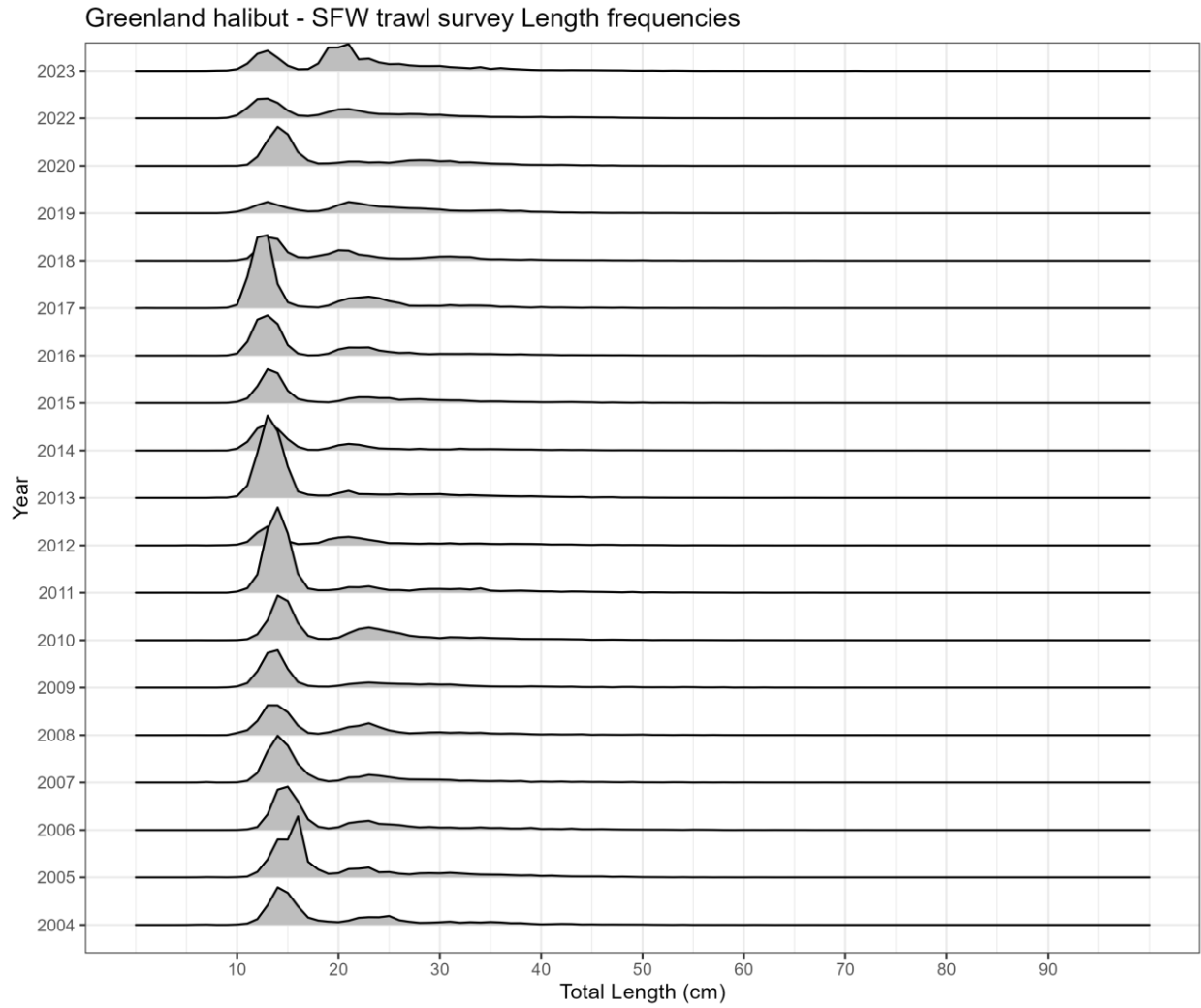


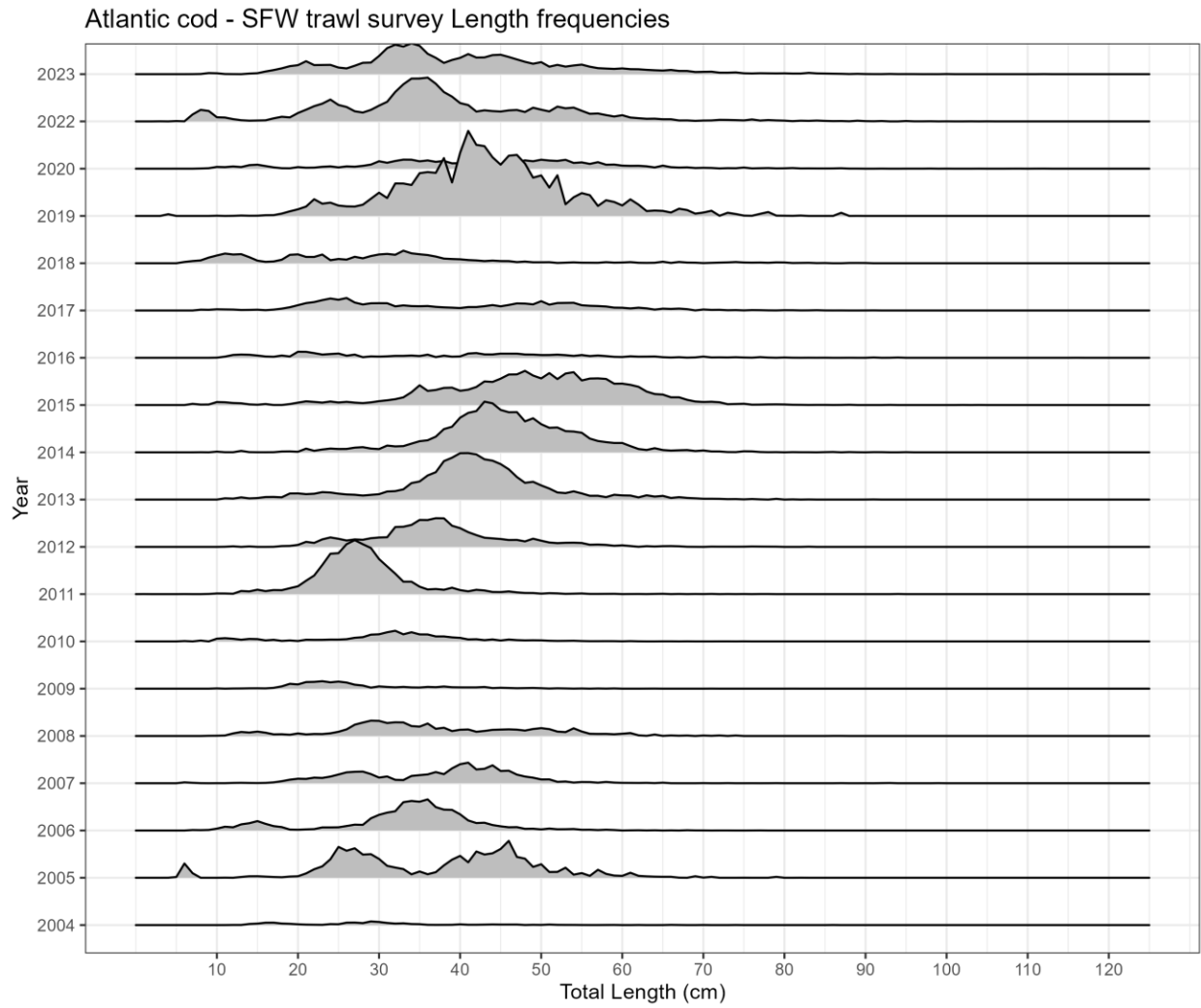
Figure 11. Number ('00000s) of one-year of Greenland halibut by division and year from 1990 to 2020.



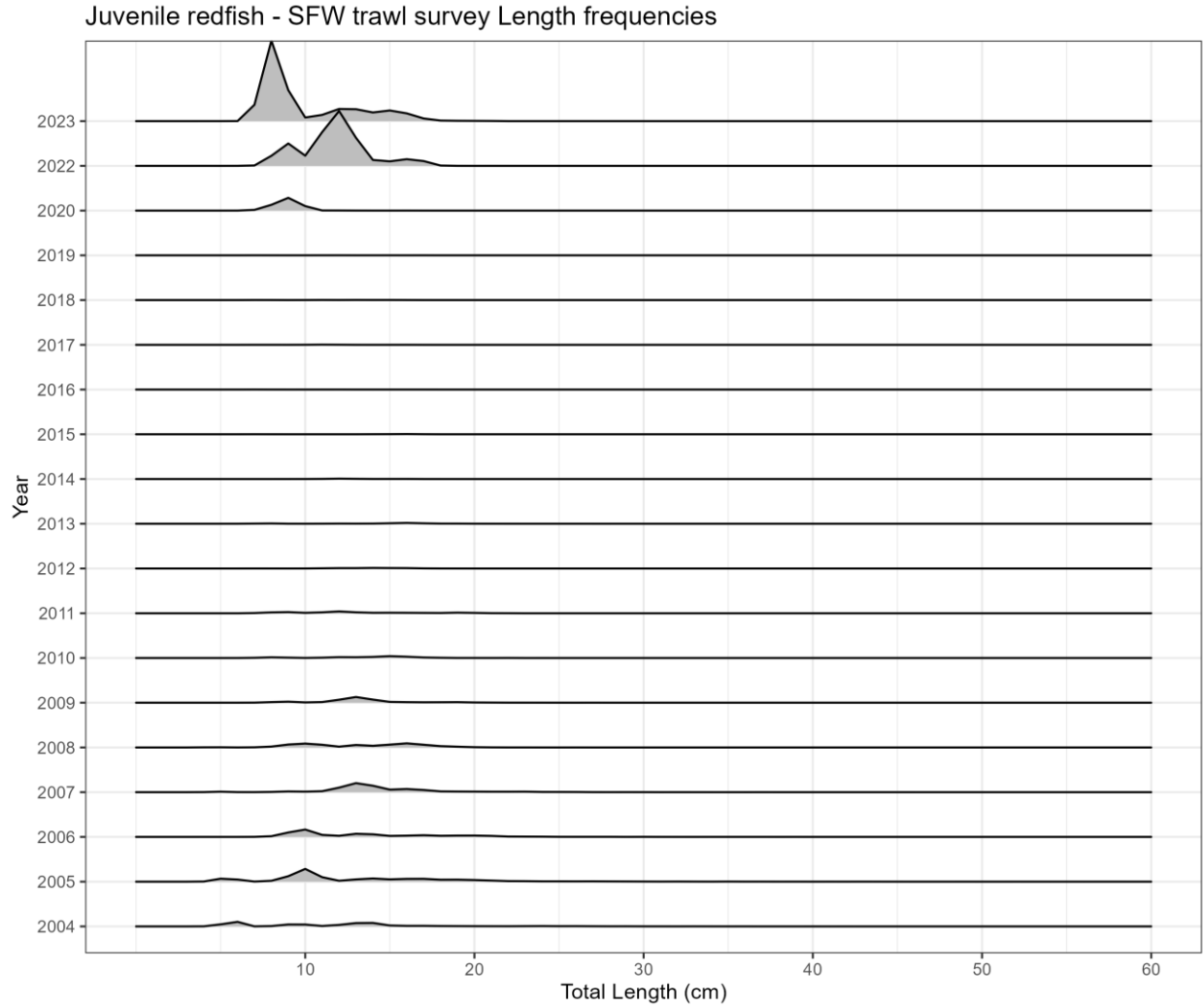
**Figure 12.** Relative distribution of one-year old Greenland halibut between offshore areas and inshore Disko Bay from 1991 to 2020.



**Figure 13.** Length frequencies for Greenland halibut offshore for the period 2006-2020.

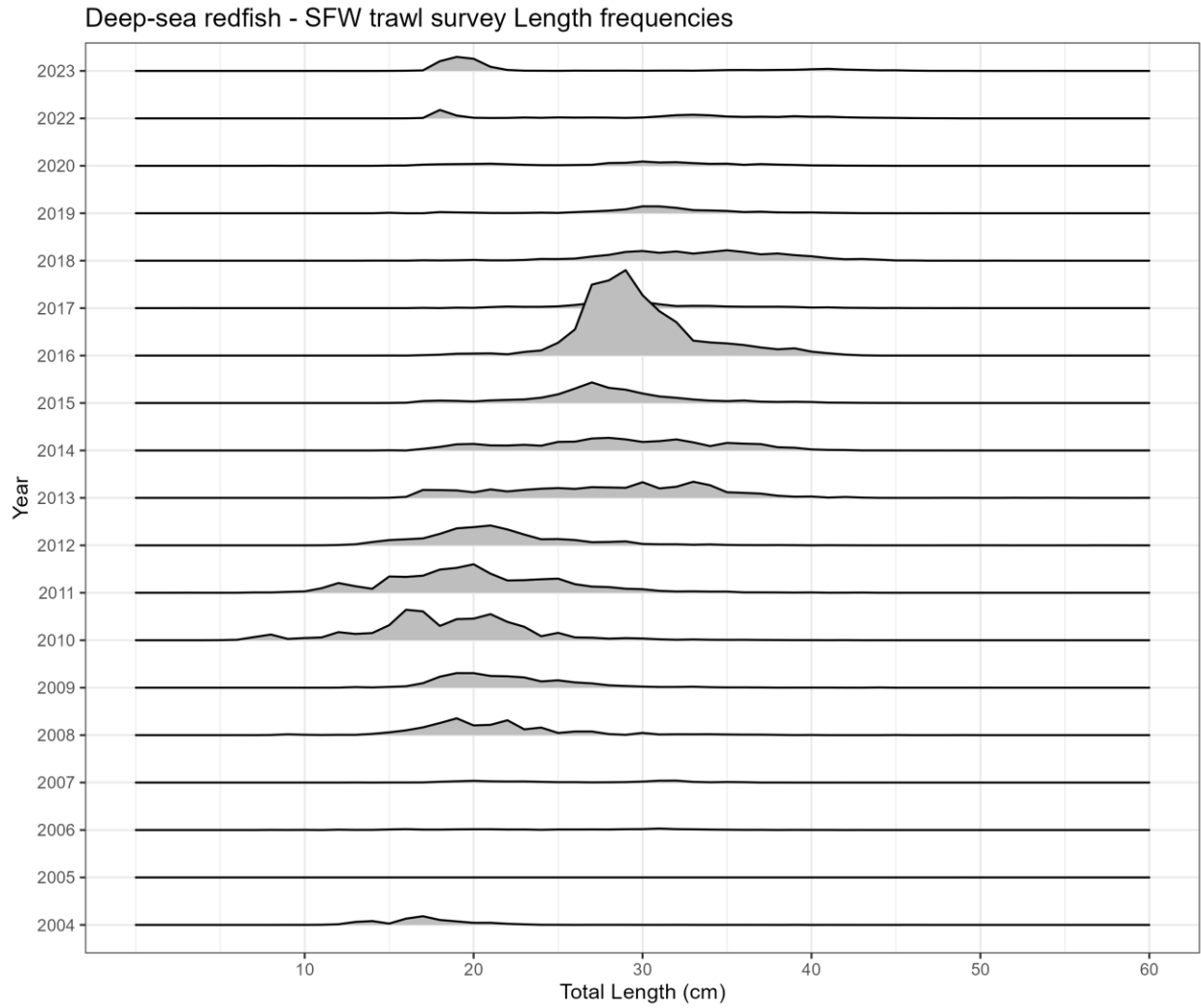


**Figure 14.** Atlantic cod (*Gadus morhua*). Length frequencies for West Greenland.

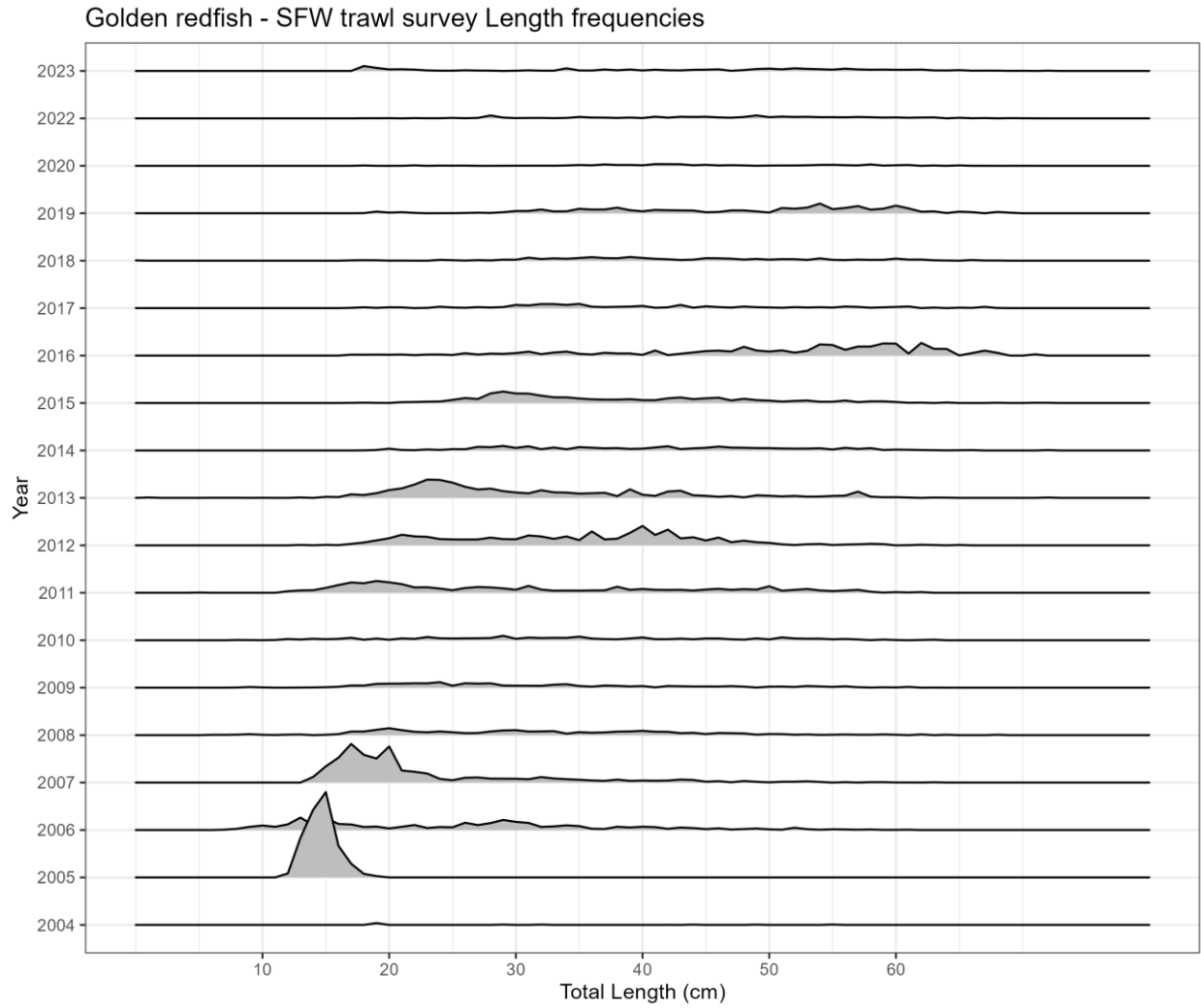


**Figure 15a.** Stacked length frequencies for juvenile redfish (*Sebastes* sp. <18cm) for West Greenland.

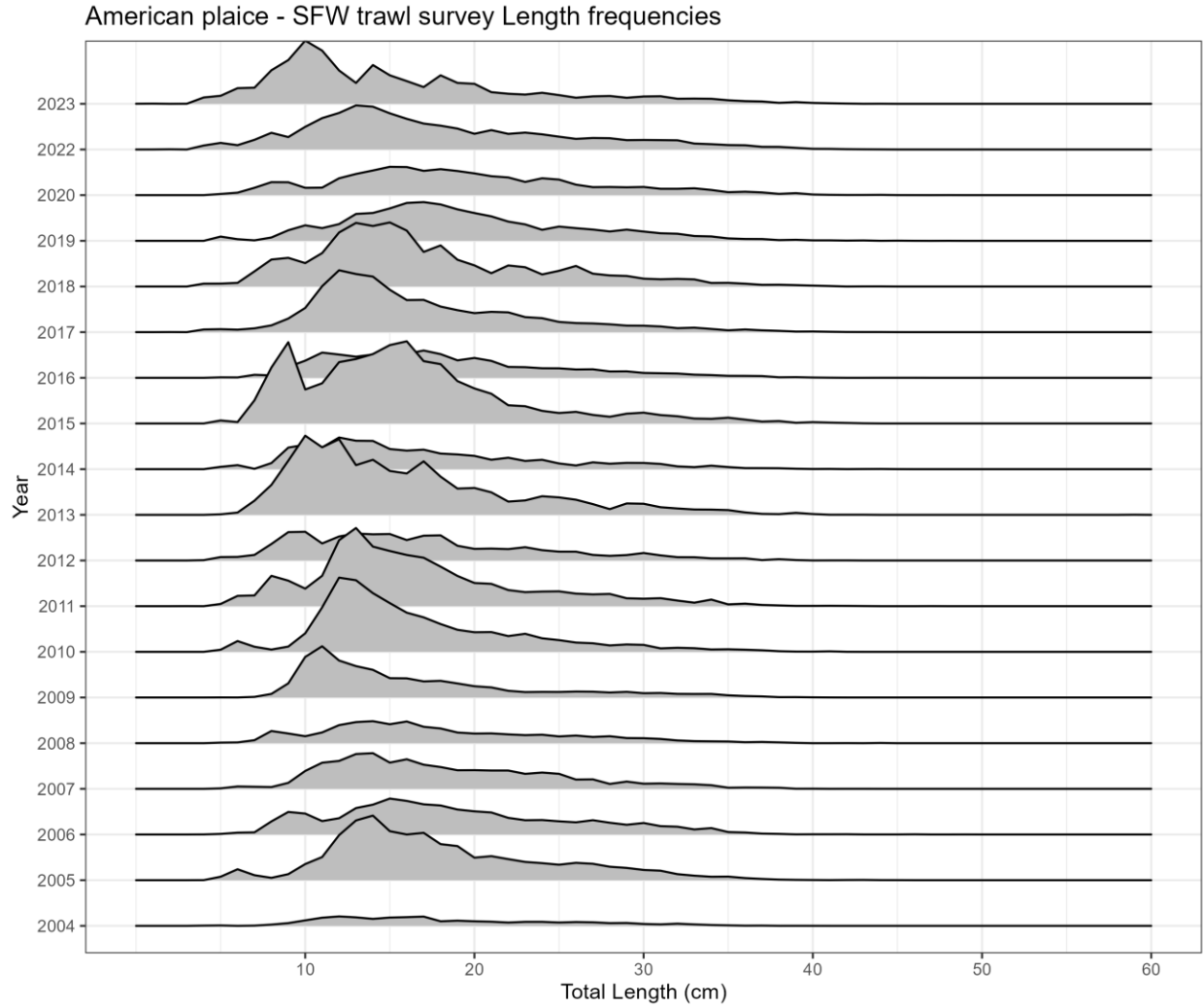




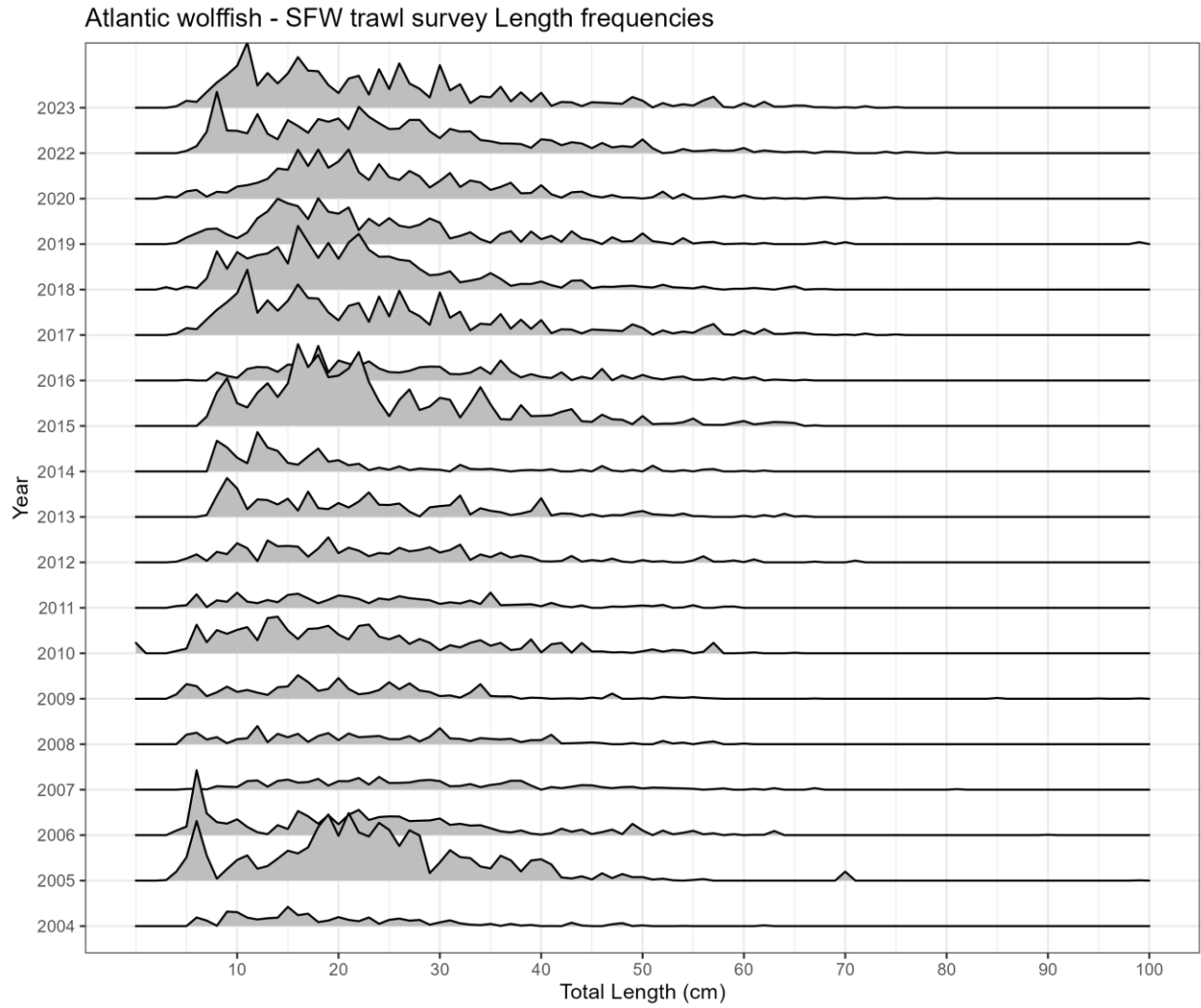
**Figure 15b.** Stacked length frequencies for deep-sea redfish (*Sebastes mentella* West Greenland).



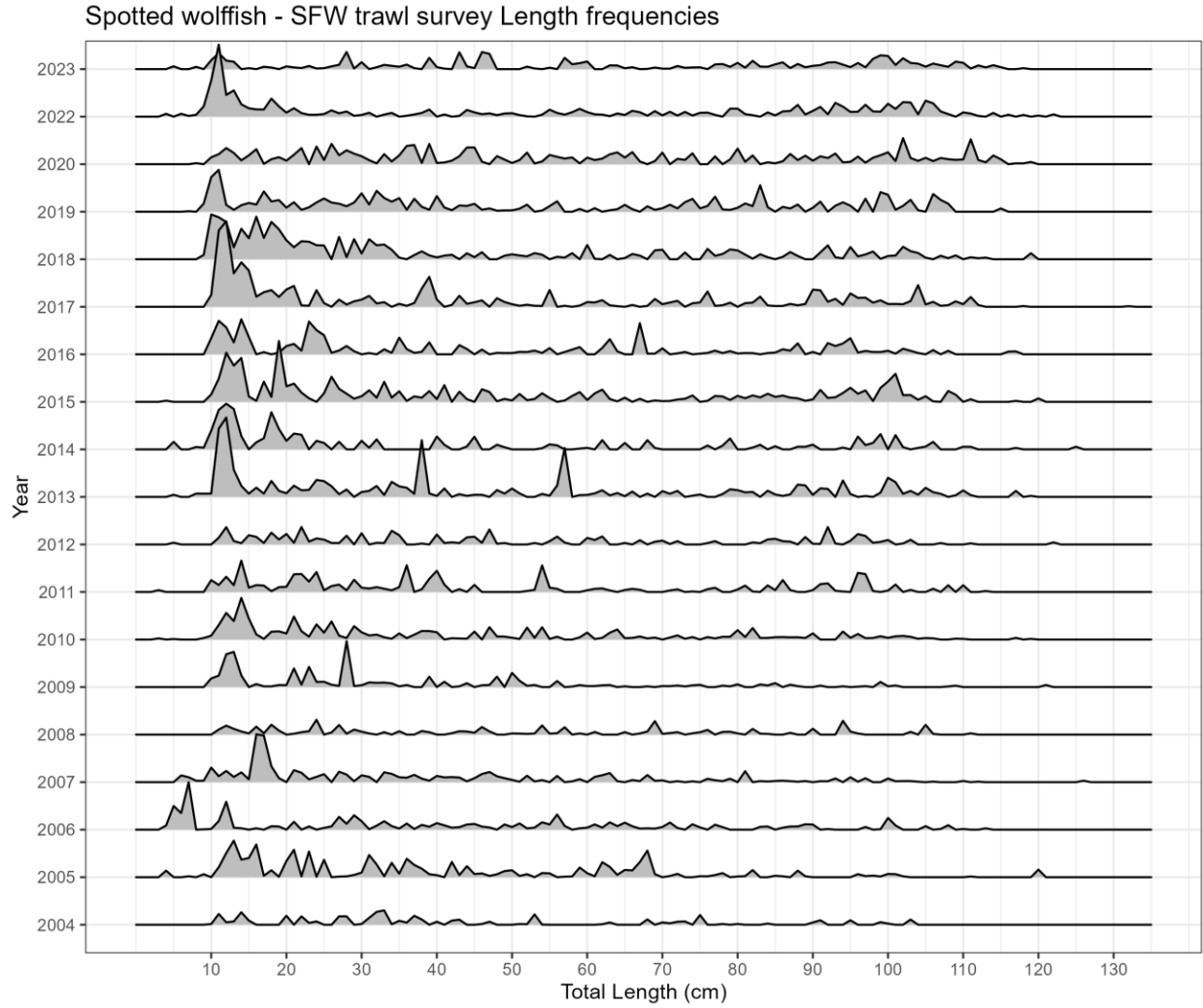
**Figure 15c.** Stacked length frequencies for golden redfish (*Sebastes Norvegicus*) West Greenland.



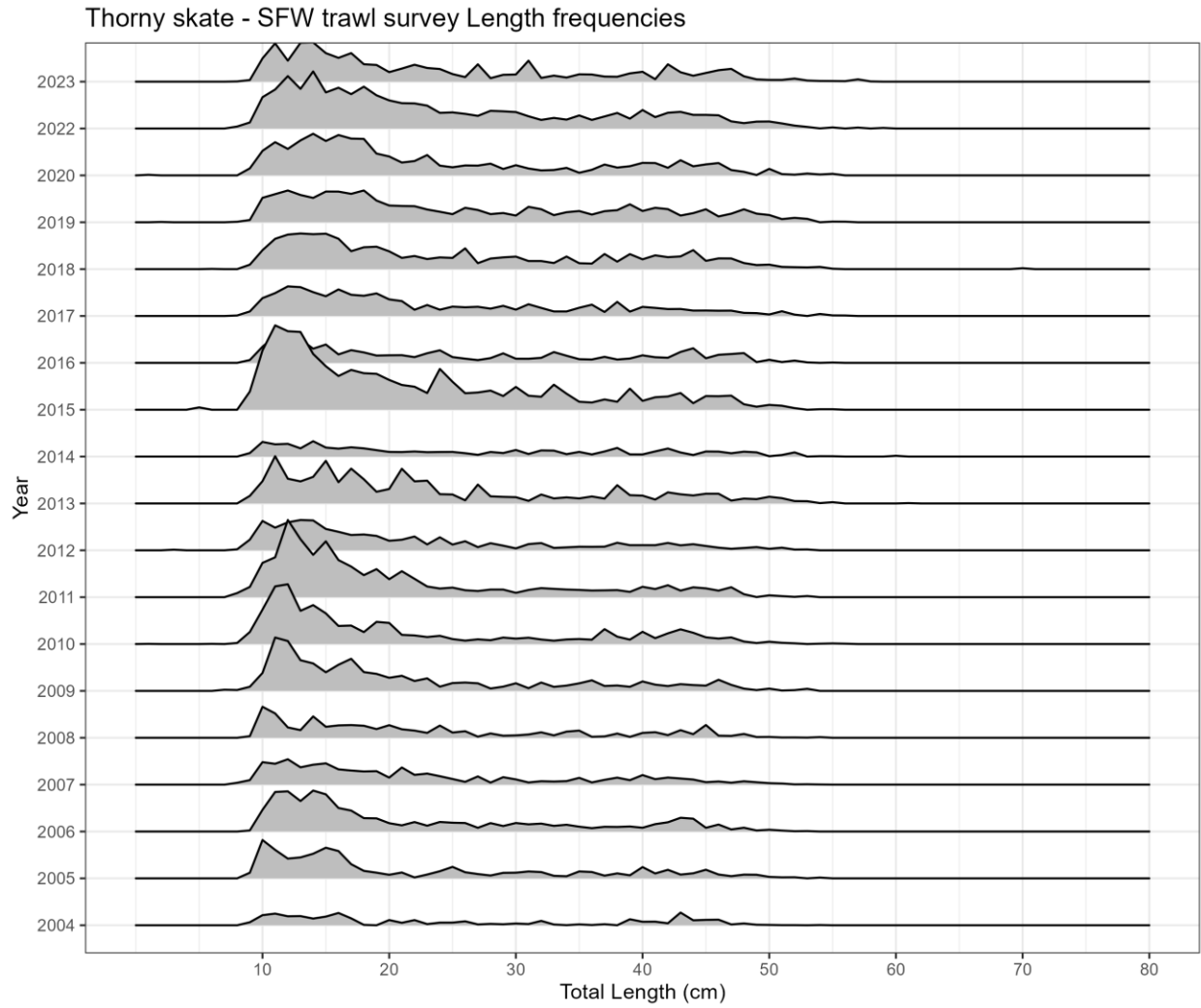
**Figure 16.** American plaice (*Hippoglossoides platessoides*). Length frequencies for West Greenland.



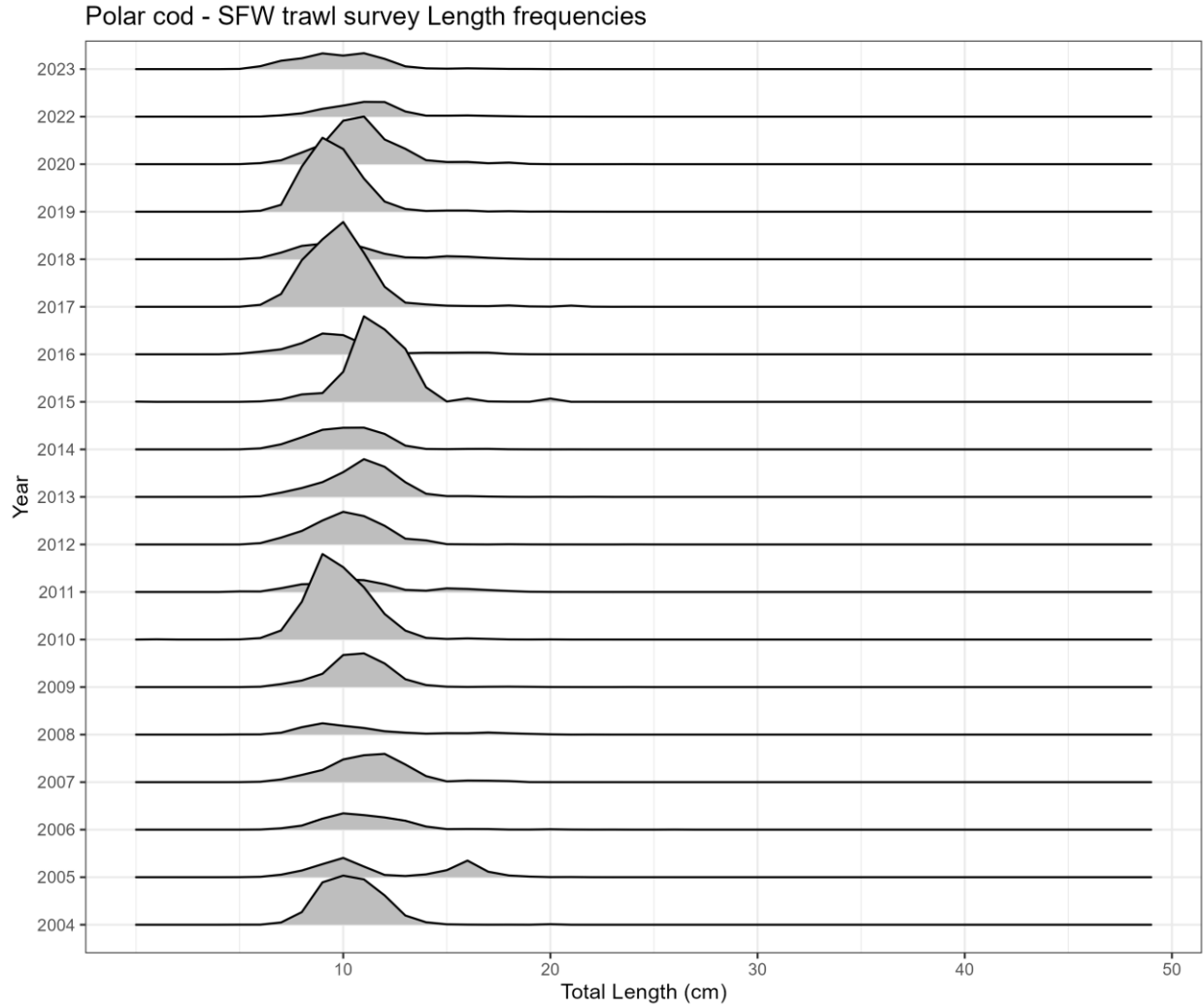
**Figure 17.** Atlantic wolffish (*Anarhichas lupus*). Length frequencies for West Greenland.



**Figure 18.** Spotted wolffish (*Anarhichas minor*). Length frequencies for West Greenland.



**Figure 19.** Thorny skate (*Amblyraja radiata*) length frequencies for West Greenland.



**Figure 20.** Polar cod (*Boreogadus saida*) length frequencies for West Greenland.

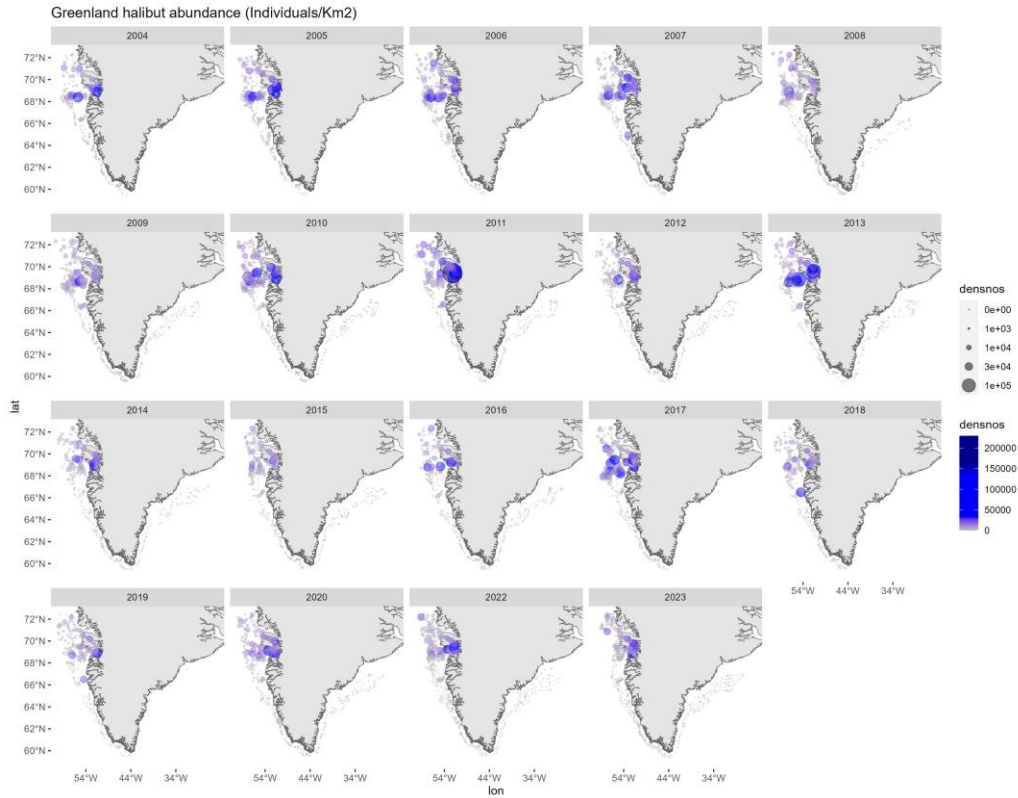


Figure. 21a. Greenland halibut survey abundance in numbers/km<sup>2</sup>.

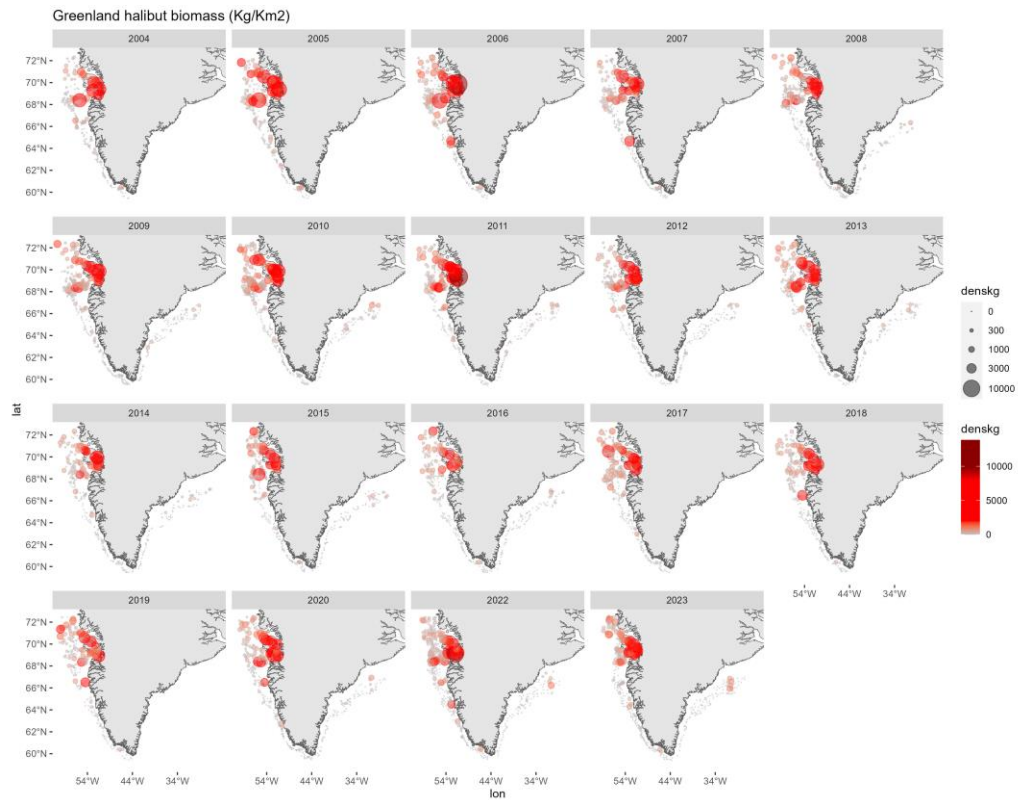


Figure. 21b. Greenland halibut survey biomass in kg/km<sup>2</sup>.



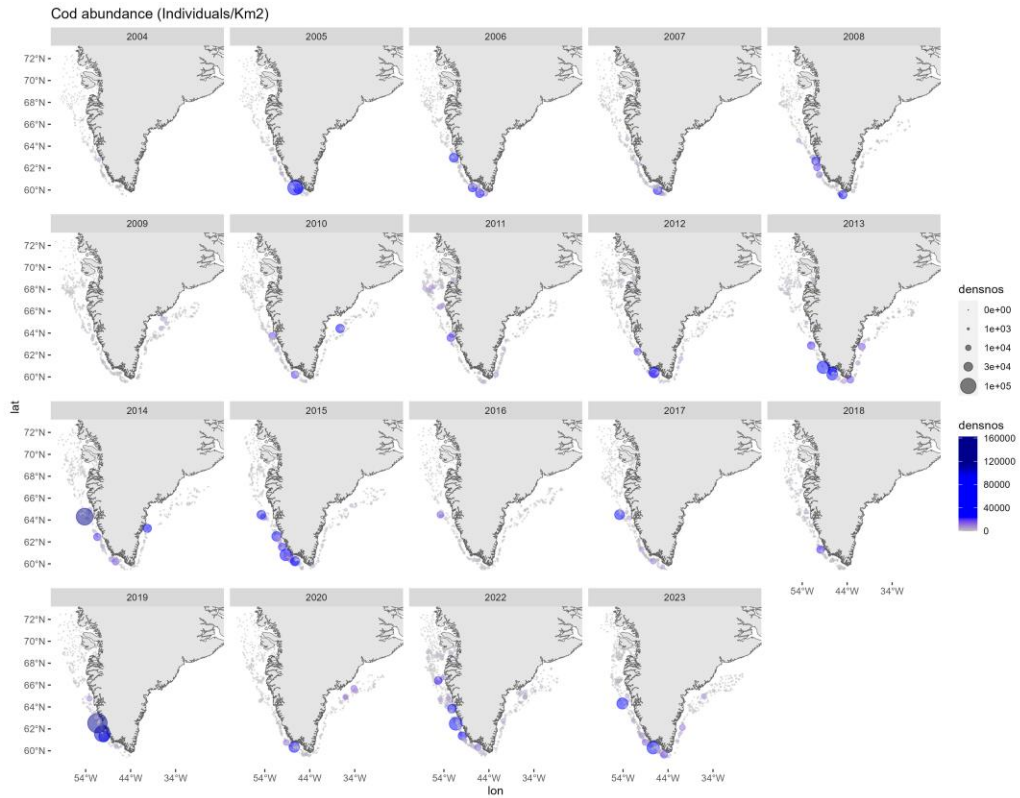


Figure 22a. Atlantic cod survey abundance in numbers/km<sup>2</sup>.

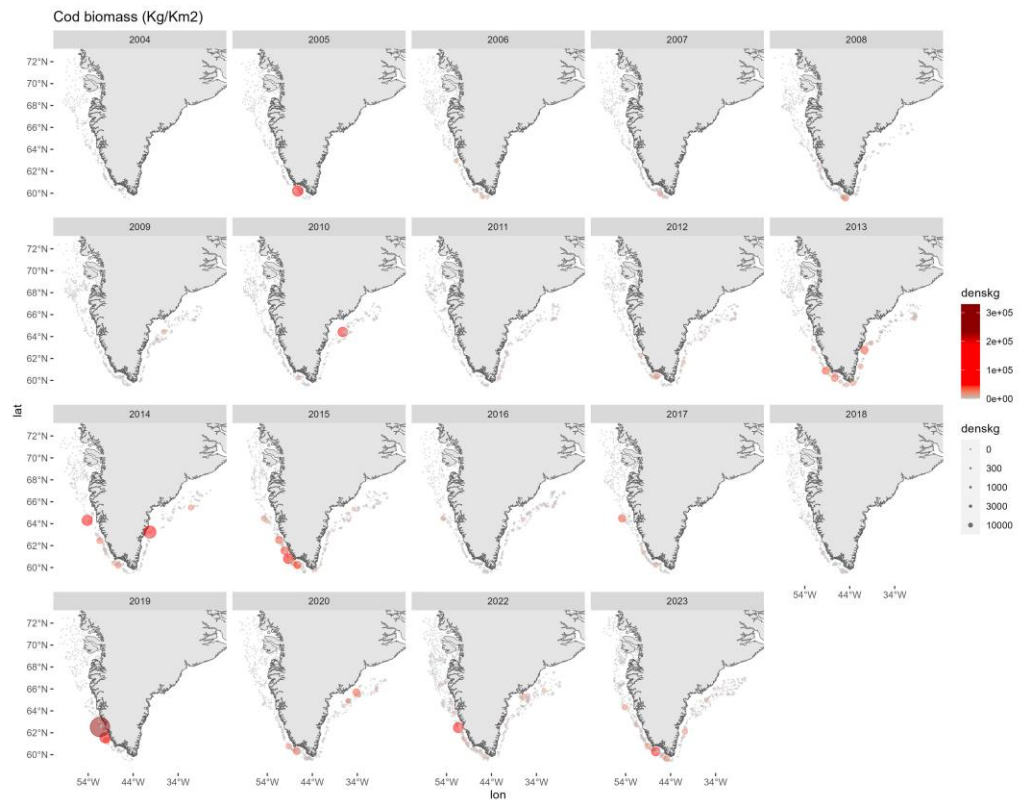


Figure 22b. Atlantic cod survey biomass in kg/km<sup>2</sup>.

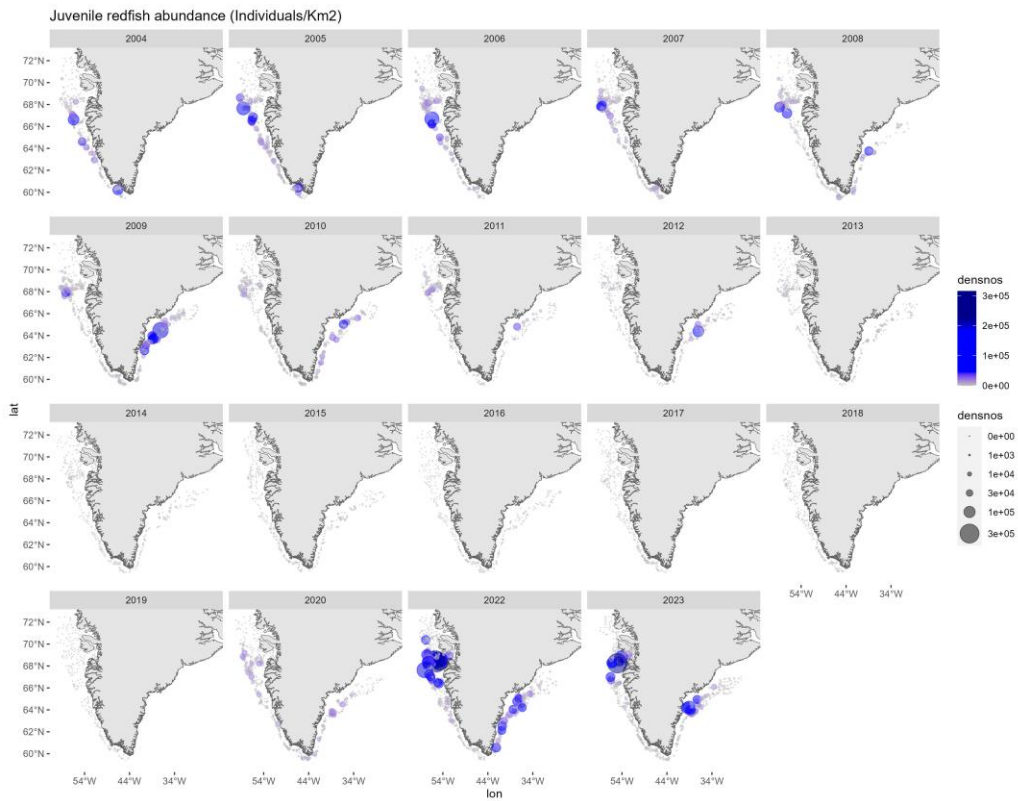


Figure 23a. Juvenile redfish < 20 cm survey abundance in numbers/km<sup>2</sup>.

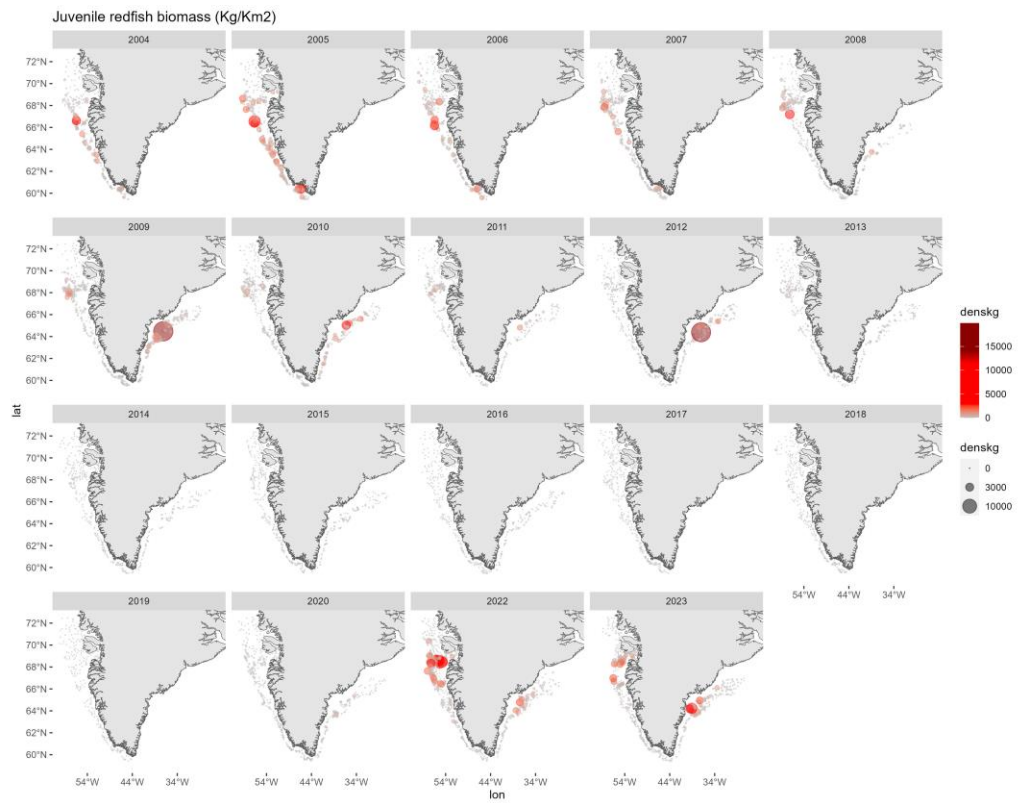


Figure 23b. Juvenile redfish < 20 cm survey biomass in kg/km<sup>2</sup>.

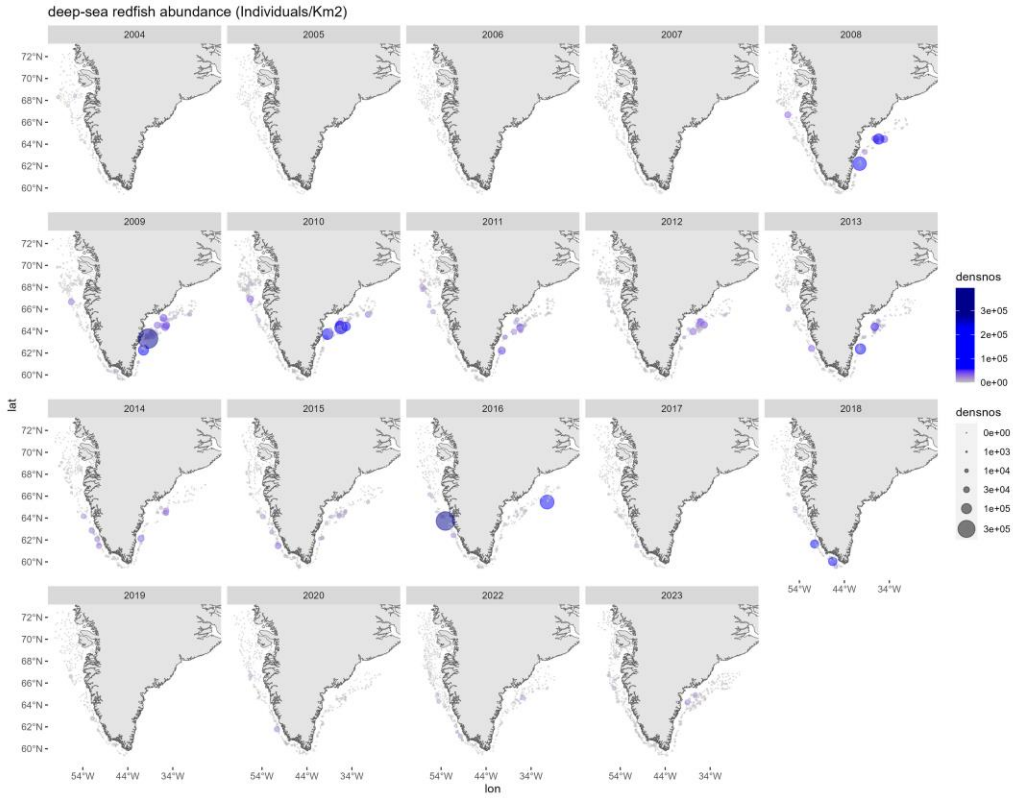


Figure 24a. Deep-sea redfish survey abundance in numbers/km<sup>2</sup>.

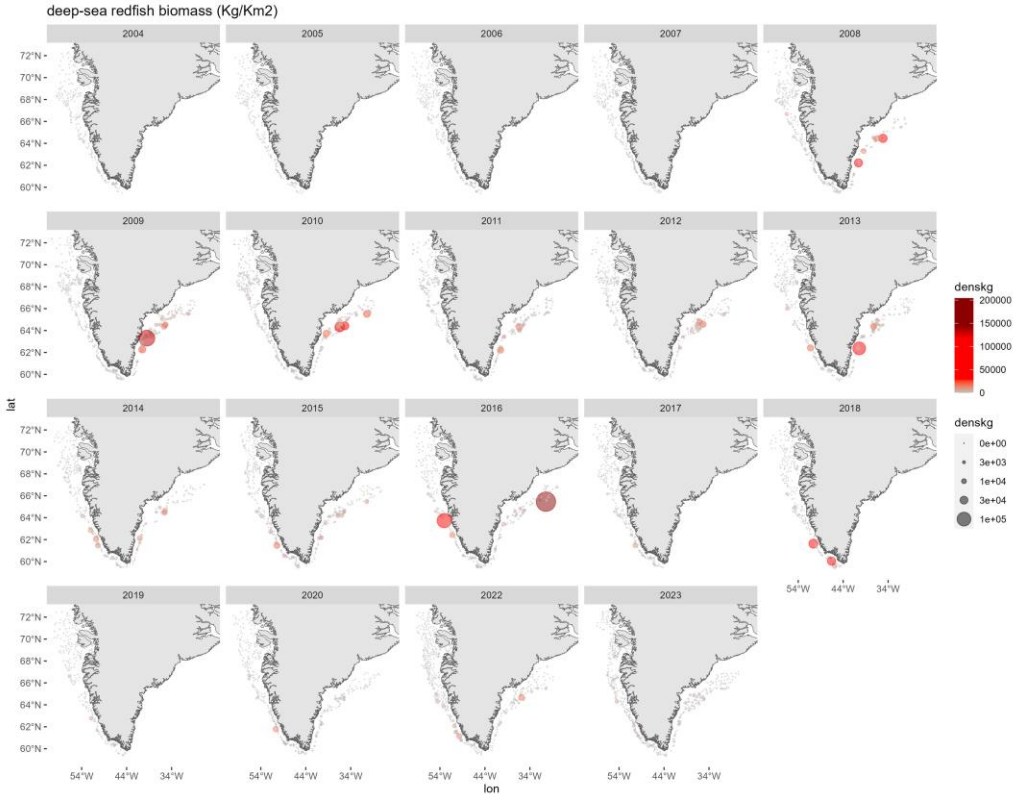


Figure 24b. Deep-sea redfish survey biomass in kg/km<sup>2</sup>.

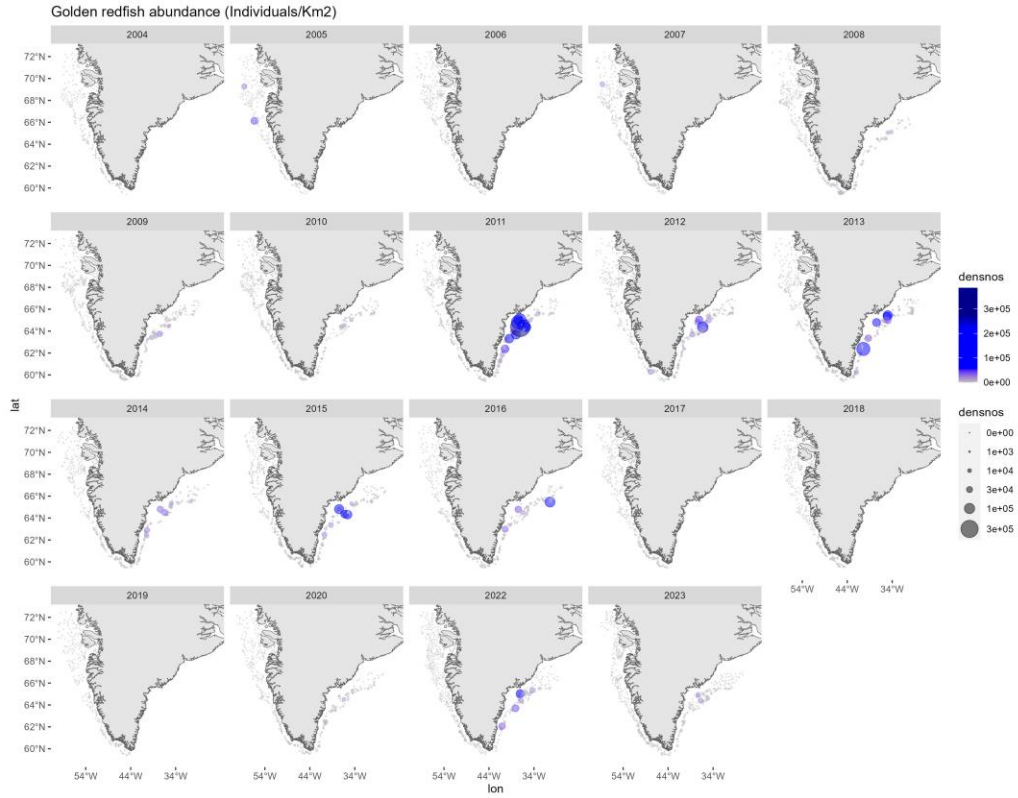


Figure 25a. Golden redfish survey abundance in numbers/km<sup>2</sup>.

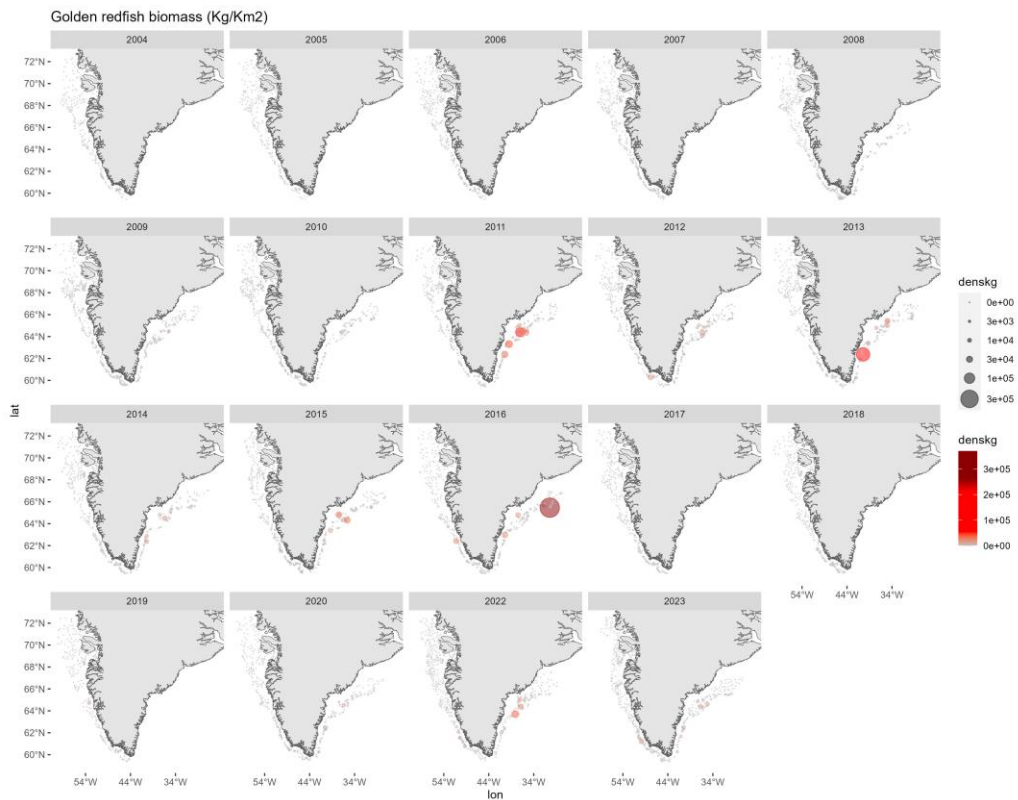
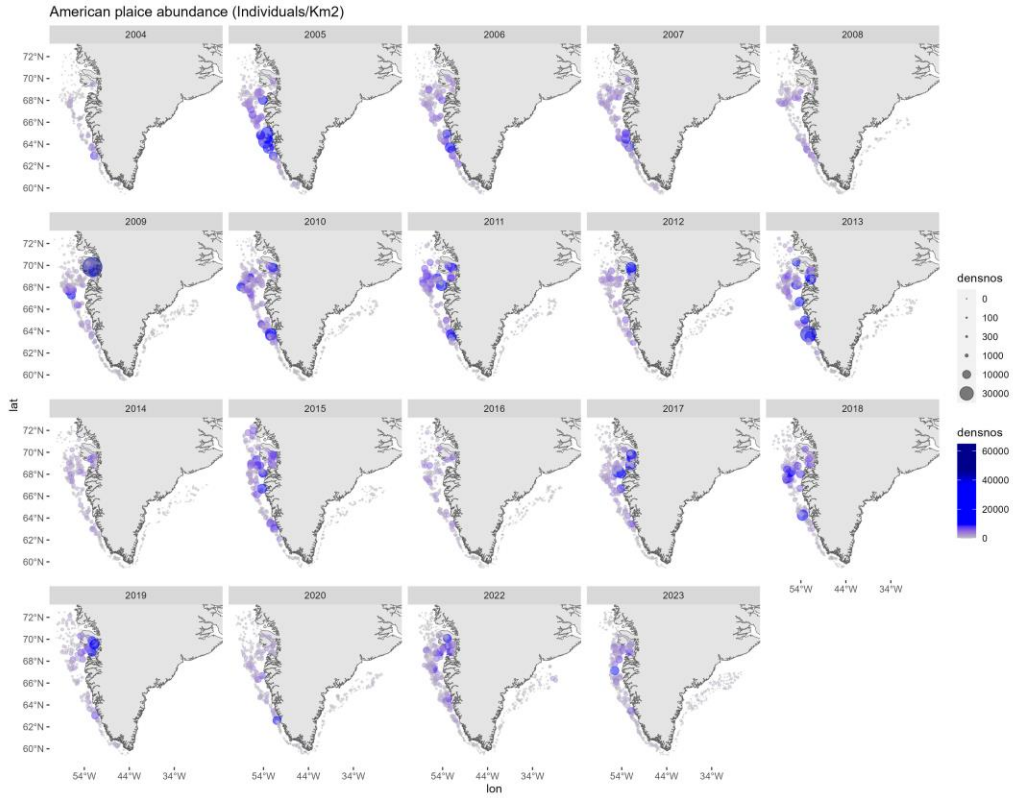
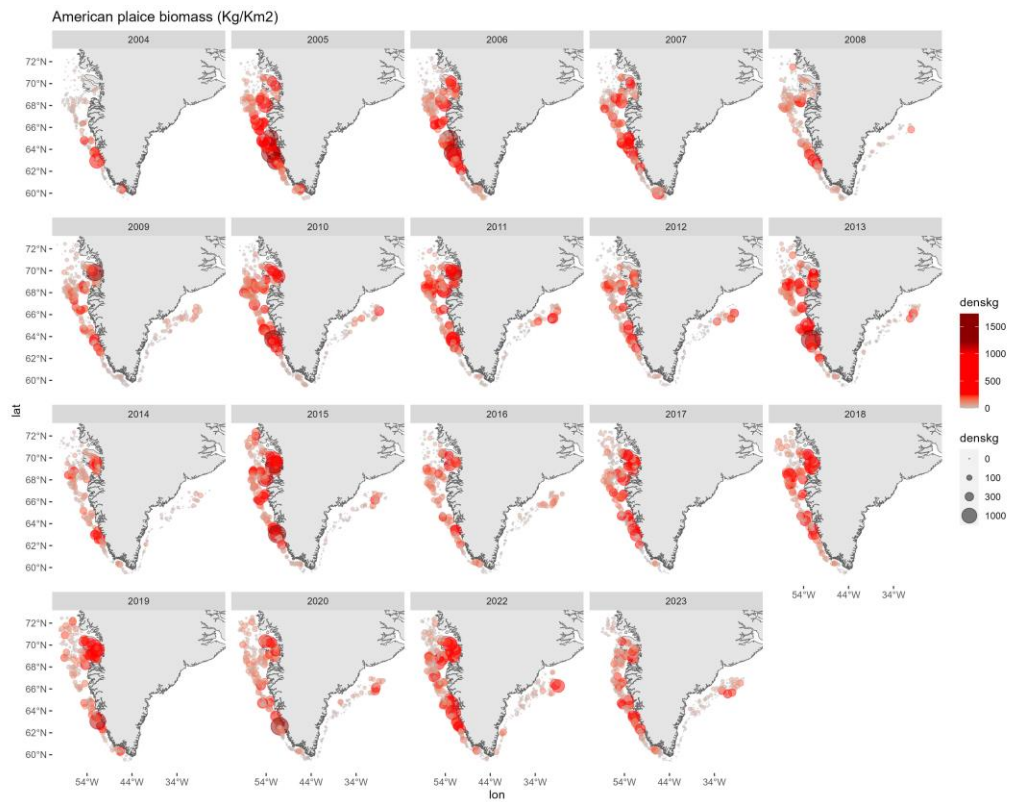


Figure 25b. Golden redfish survey biomass in kg/km<sup>2</sup>.



**Figure 26a.** American plaice survey abundance in numbers/km<sup>2</sup>.



**Figure 26b.** American plaice survey biomass in kg/km<sup>2</sup>.

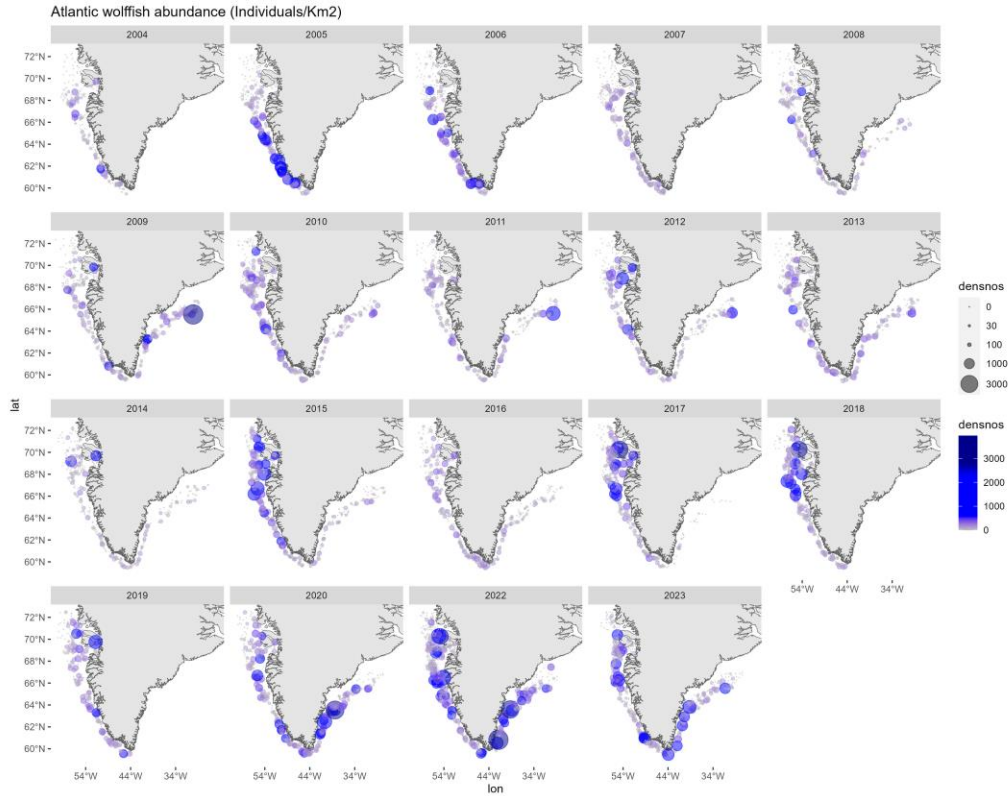


Figure 27a. Atlantic wolffish survey abundance in numbers/km<sup>2</sup>.

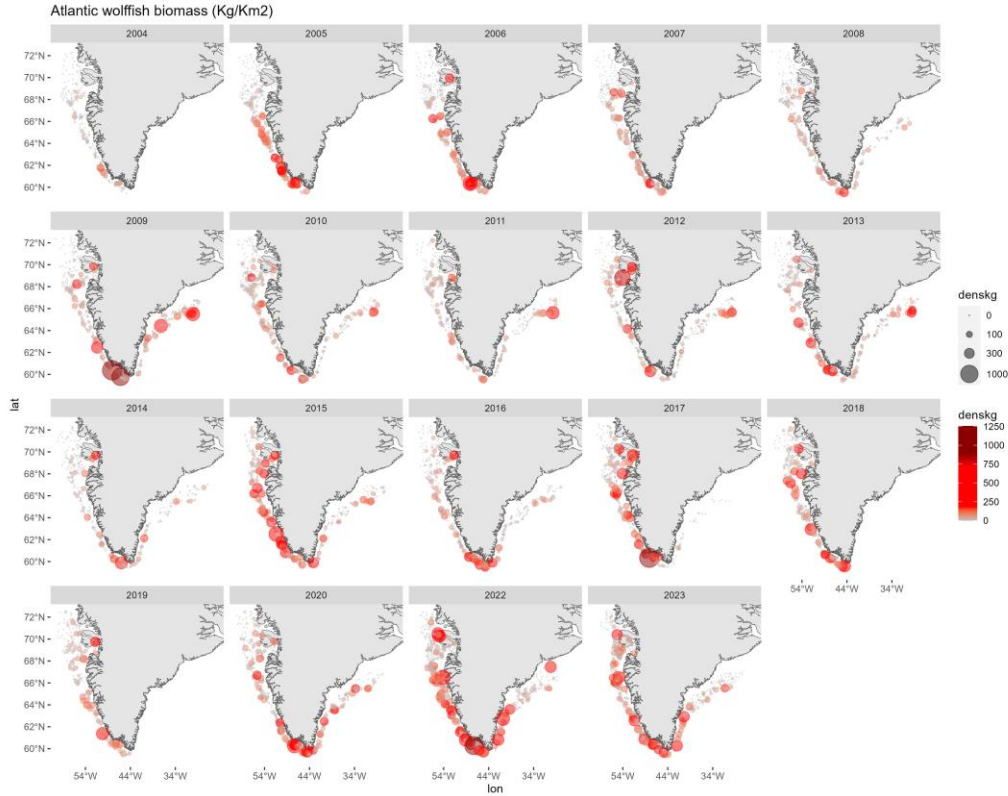


Figure 27b. Atlantic wolffish survey biomass in kg/km<sup>2</sup>.

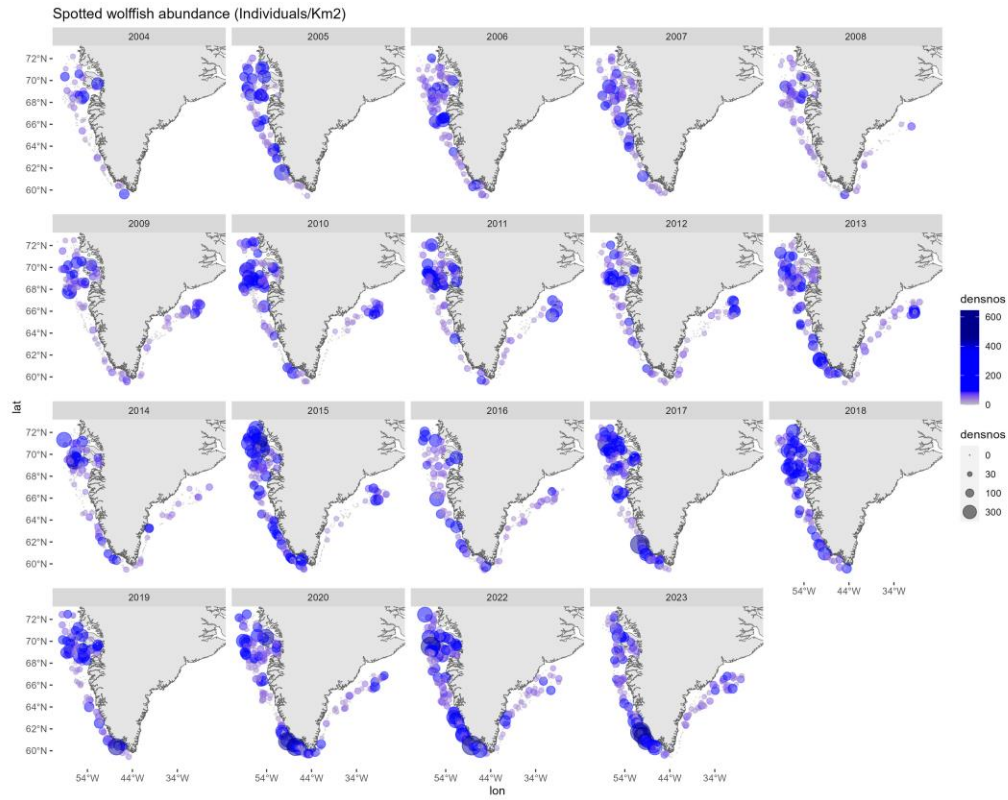


Figure 28a. Spotted wolffish survey abundance in numbers/km<sup>2</sup>.

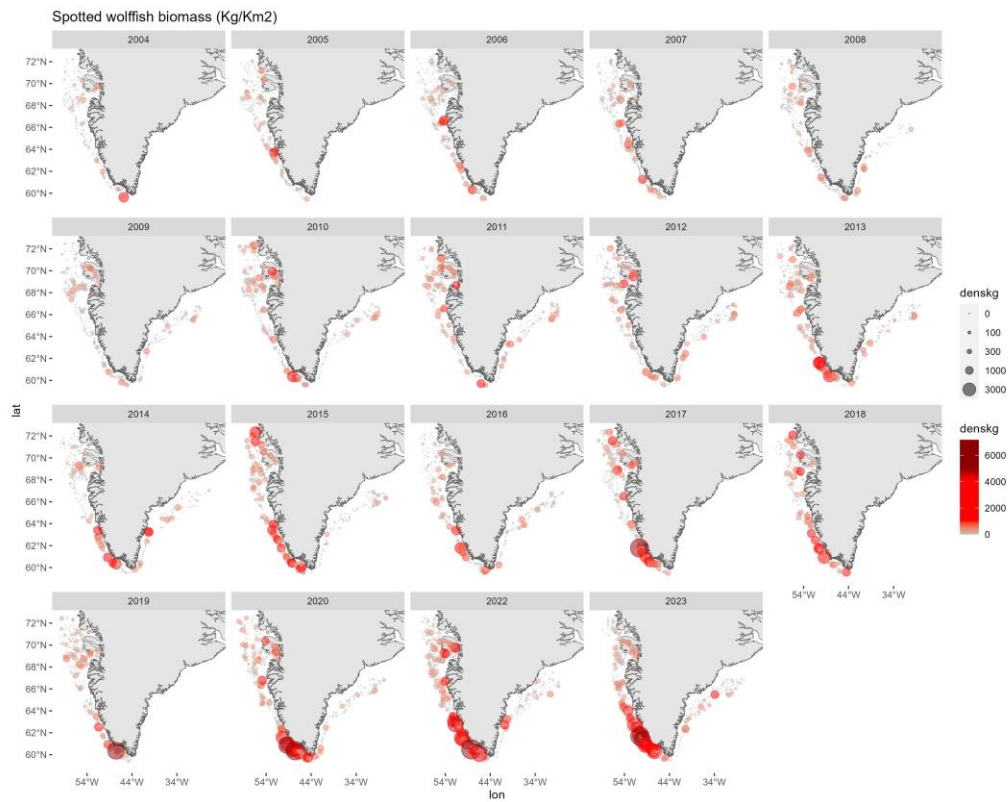
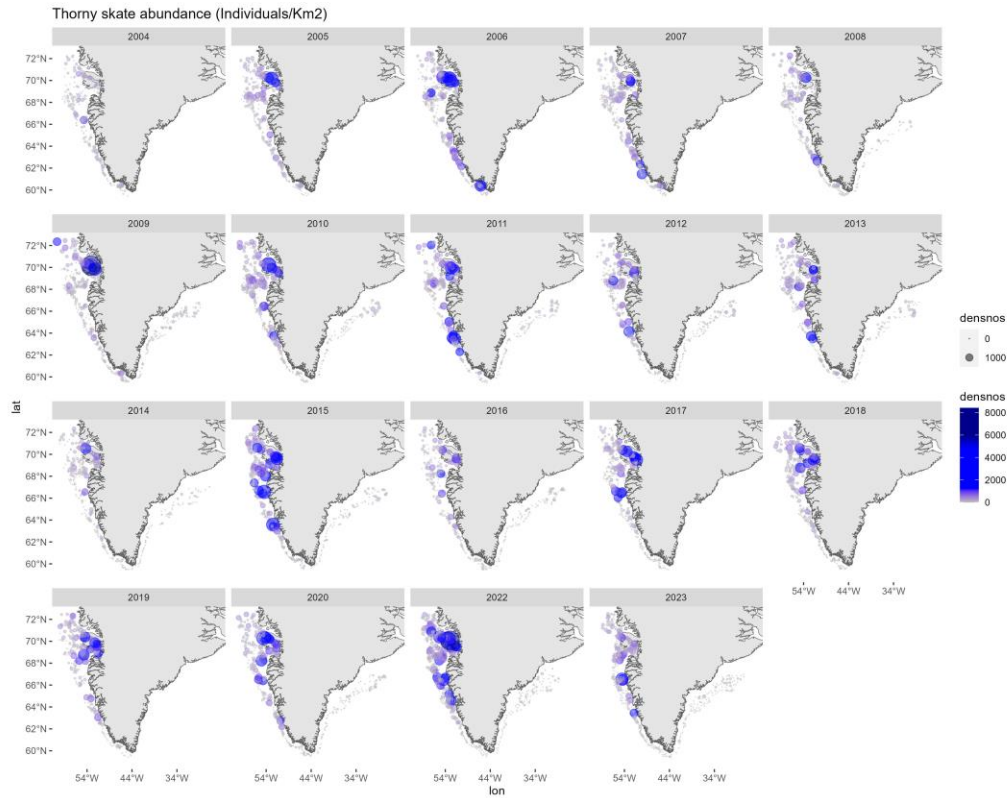
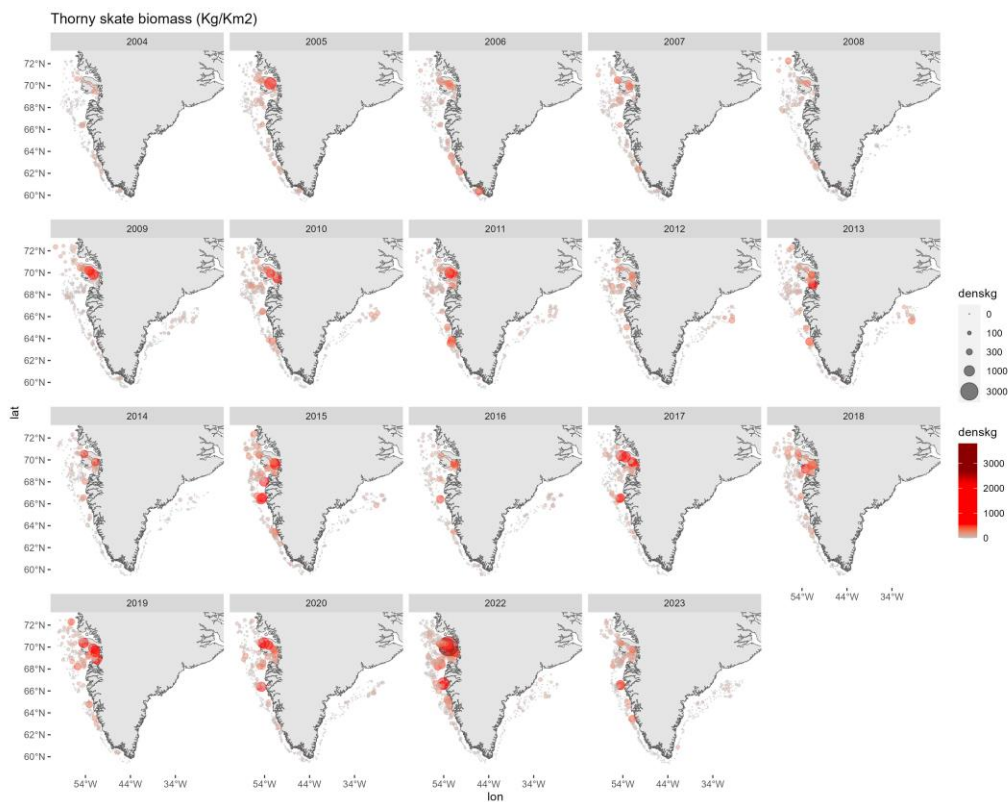


Figure 28b. Spotted wolffish survey biomass in kg/km<sup>2</sup>.



**Figure 29a.** Thorny skate survey abundance in numbers/km<sup>2</sup>.



**Figure 29b.** Thorny skate survey biomass in kg/km<sup>2</sup>.



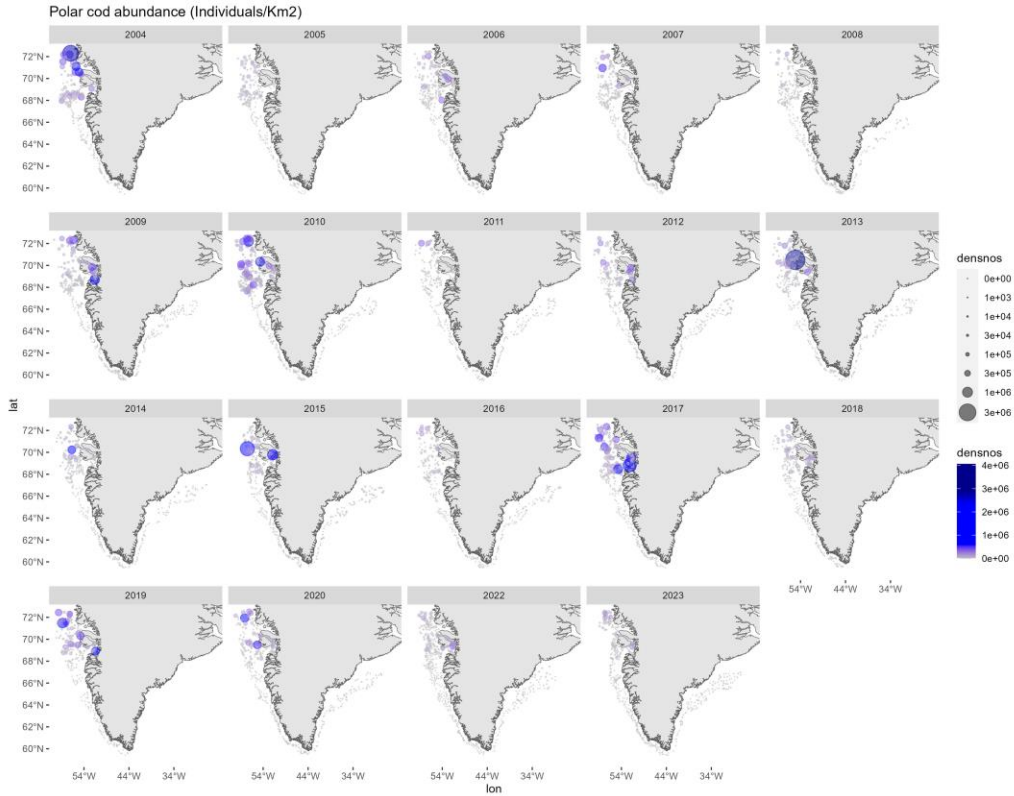


Figure 30a. Polar cod survey abundance in numbers/km<sup>2</sup>.

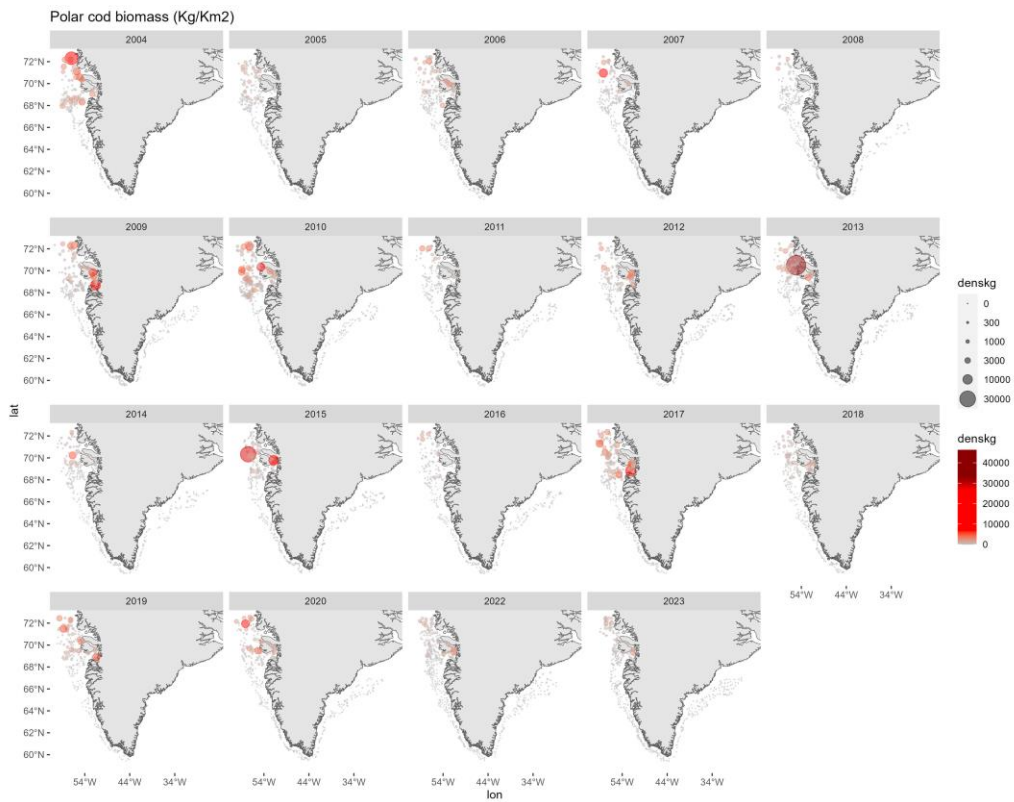


Figure 30b. Polar cod survey biomass in kg/km<sup>2</sup>.